

NÁVOD

Garlist SDG-03 Zahradní domek - Šedá

S0810A -2228M

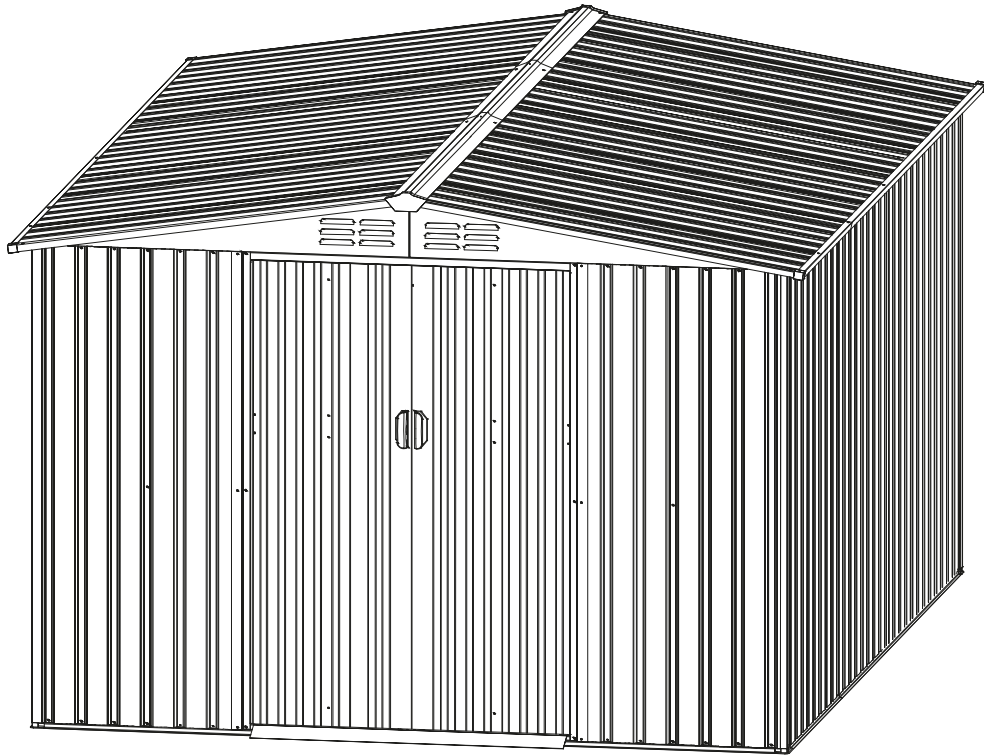

Doporučené nástroje



DŮLEŽITÉ: Uschovejte pro budoucí použití. Pečlivě si přečtěte.

PŘÍPRAVA K MONTÁŽI

Před zahájením stavby zkontrolujte místní stavební předpisy týkající se základů, umístění a dalších požadavků. Prostudujte si tento návod – obsahuje důležité informace a užitečné tipy, které usnadní a zpříjemní montáž.

Instrukce k montáži:

Před zahájením si přečtěte všechny pokyny a informace. Pro úspěšný výsledek se ujistěte, že postupujete krok za krokem podle uvedené posloupnosti.

Základ / podlaha:

Pozemek musí být připraven tak, aby základna domku byla vodorovná ze všech stran – nutná je kontrola pomocí vodováhy.

Základ může být vyroben z impregnovaného dřeva nebo betonu, aby se zabránilo pronikání vlhkosti do domku.

Domek nesmí být postaven přímo na trávu, protože zem během deště měkne a bahní. Pokud se dělá betonová deska, musí být mírně vyspádovaná k okrajům, aby se zabránilo pronikání vody. Beton musí být zcela suchý, než na něj domek postavíte.

Základna může být také vytvořena z cihel, tvárnic, nebo umístěna na betonovou desku. Cihly nebo tvárnice musí být pevně usazeny do roviny a konstrukce domku na ně následně přišroubována.

Díly a seznam dílů:

Před zahájením montáže roztříděte a zkontrolujte všechny díly a spojovací materiál, abyste měli jistotu, že nic nechybí (viz strana Seznam dílů).

Nepokoušejte se domek sestavit, pokud nějaké díly chybí.

Částečně sestavený domek může být snadno poškozen i slabým větrem.

Bezpečnost musí být na prvním místě:

Vyberte si pro montáž suchý a bezvětřný den. Na montáž jsou potřeba alespoň dvě osoby. Používejte ochranné rukavice, brýle a dlouhé rukávy, abyste předešli zranění ostrými hranami dílů.

Děti a domácí zvířata nemají na staveništi co dělat.

Nestoupejte celou vahou na střechu domku. Pokud používáte schůdky, ujistěte se, že jsou bezpečné.

Údržba a péče:

Udržujte domek čistý – používejte měkký hadřík, v případě potřeby vodu.

Udržujte dveřní kolejnice čisté, bez nečistot, aby dveře mohly hladce jezdit.

Odstraňujte sníh vhodnými nástroji, aby byl vstup bezpečný. Těžký sníh může způsobit zřícení střechy – vždy dbejte na bezpečnost.

Domek není určen k bydlení, ale pouze ke skladování věcí.

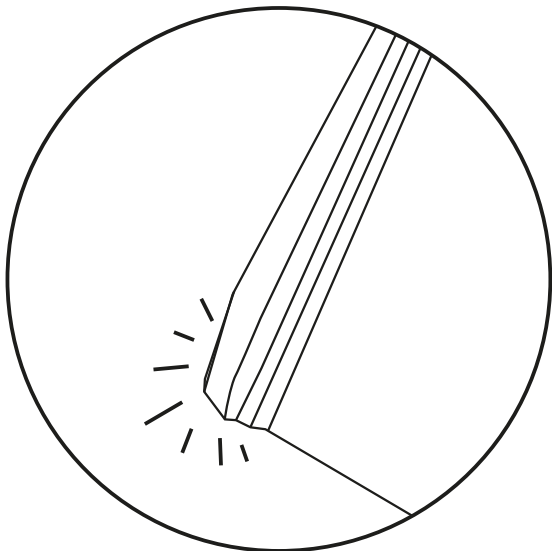

CZ – UPOZORNĚNÍ:



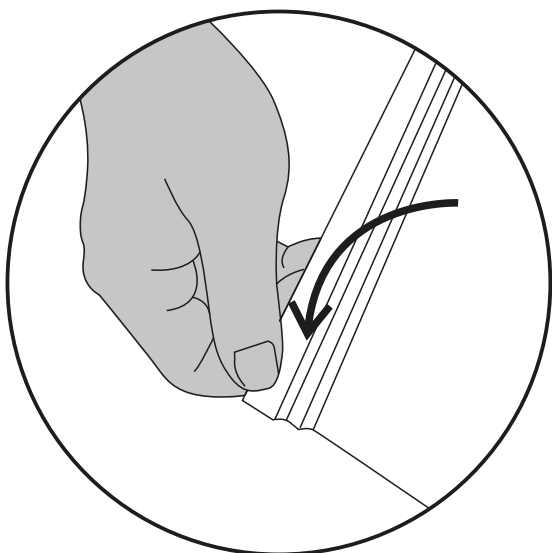



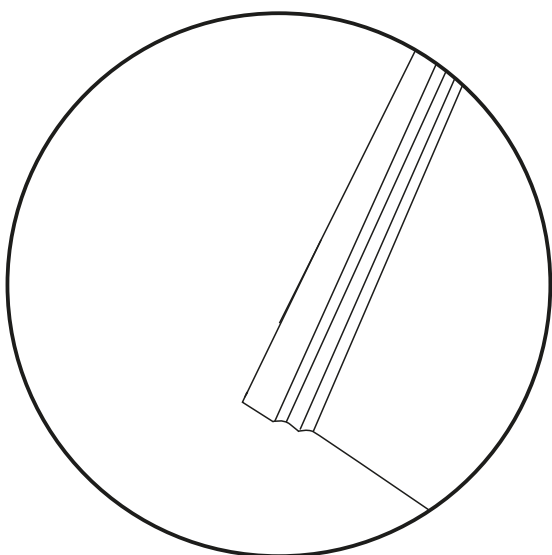



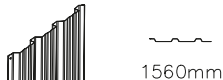

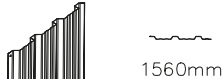

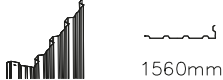

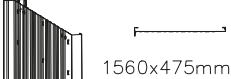

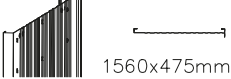
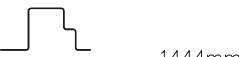



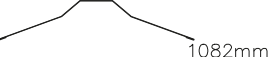
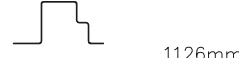
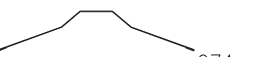
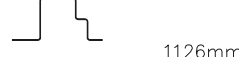

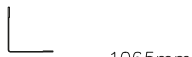
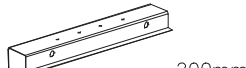



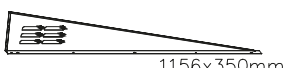

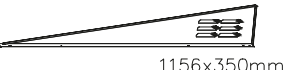
Pokud jsou rohy lehce ohnuté, je to v pořádku.







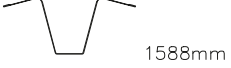







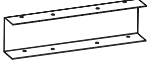

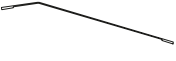
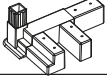
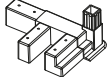



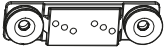

Noste rukavice a lehce narovnejte rohy,
dokud nebudou rovné.



Poté budou panely zase v normálním stavu
a nebude to mít žádný vliv na montáž.

| Karton:1/2 | | | | | |
|------------|---|----|-----|---|---|
| Č. | DÍL. | P. | | | |
| W3 |  | 23 | W15 |  | 8 |
| W4 |  | 2 | 1L |  | 1 |
| W7 |  | 4 | 1R |  | 1 |
| M1 |  | 1 | 2LF |  | 1 |
| M2 |  | 1 | 2LB |  | 1 |
| 17L |  | 1 | 2RF |  | 1 |
| 17R |  | 1 | 2RB |  | 1 |
| 18 |  | 2 | 3L |  | 1 |
| 18Z |  | 1 | 3R |  | 1 |
| 19 |  | 2 | 4F |  | 2 |
| 19L |  | 2 | 4B |  | 3 |
| 19R |  | 2 | 5 |  | 4 |
| 20 |  | 4 | 6L |  | 1 |
| 21L |  | 2 | 6R |  | 1 |
| 21R |  | 2 | 7F |  | 2 |
| 22 |  | 6 | 7B |  | 2 |
| 23 |  | 1 | 8L |  | 1 |
| Karton:2/2 | | | 8R |  | 1 |
| Č. | DÍL. | P. | | | |
| W12 |  | 6 | 9F |  | 1 |
| | | | 9B |  | 1 |
| | | | 10 |  | 3 |
| | | | 10F |  | 2 |

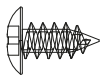
| | | | | | |
|-----|---|-----|----------|---|---|
| 11L |  350mm | 2 | S9 |  | 4 |
| 11R |  350mm | 2 | Rukavice |  | 2 |
| 12 |  120mm | 1 | Brožura |  | 1 |
| 15 |  920mm | 2 | | | |
| A |  | 1 | | | |
| B |  | 1 | | | |
| C |  | 2 | | | |
| D |  | 1 | | | |
| E |  | 1 | | | |
| F |  | 2 | | | |
| F1 |  | 4 | | | |
| F2 |  | 2 | | | |
| F3 |  | 4 | | | |
| F4 |  | 4 | | | |
| F5 |  | 2 | | | |
| F7 |  | 395 | | | |
| F8 |  | 84 | | | |
| F10 |  | 4 | | | |
| S4 |  | 415 | | | |
| S6 |  | 90 | | | |
| S7 |  | 90 | | | |
| S8 |  | 16 | | | |

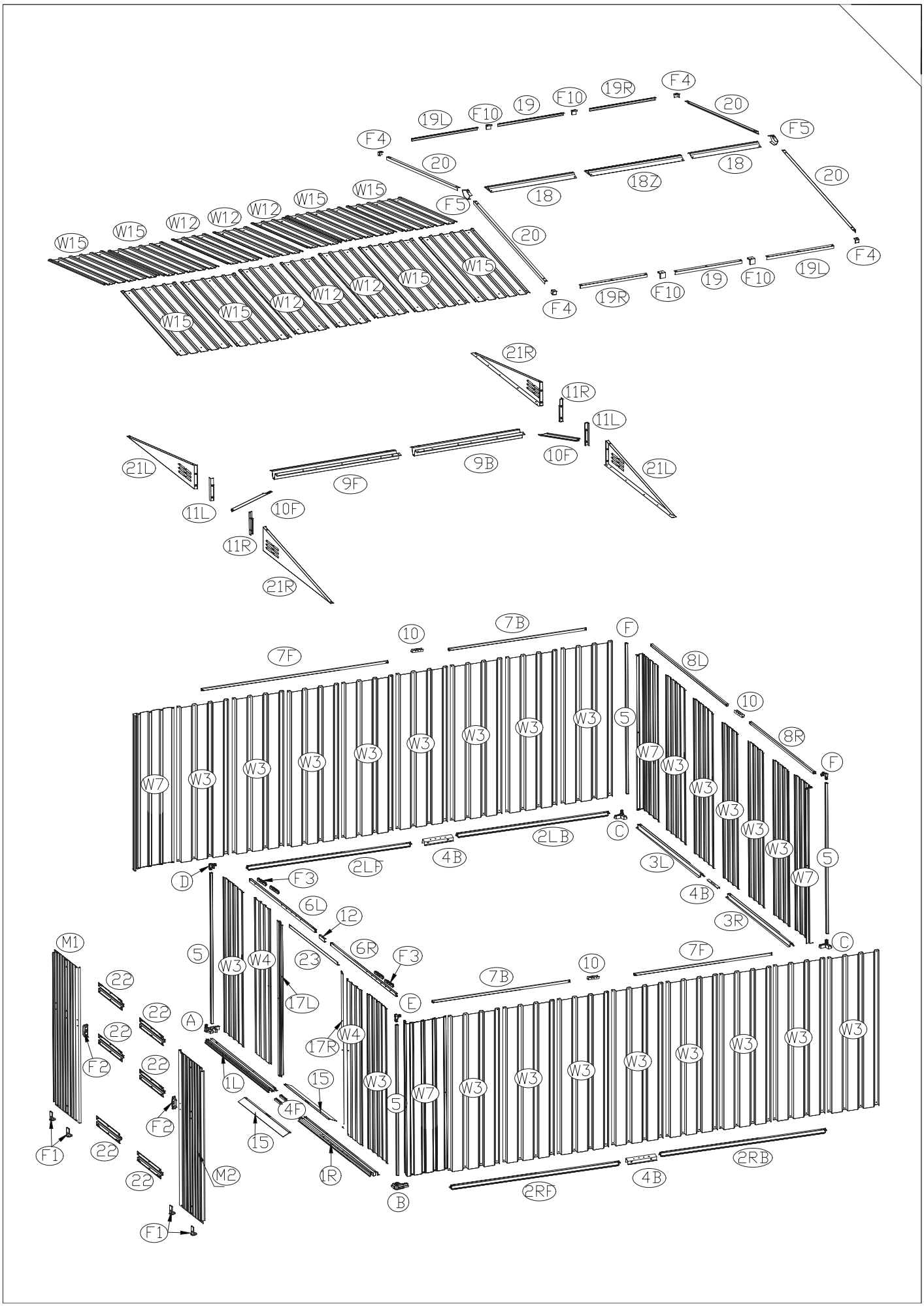

| Č. | DÍL | MM | P |
|---------------|------|------|----|
| SPODEK | | | |
| 1L | | 1126 | 1 |
| 1R | | 1126 | 1 |
| 2LF | | 1401 | 1 |
| 2RF | | 1401 | 1 |
| 2LB | | 1444 | 1 |
| 2RB | | 1444 | 1 |
| 3L | | 1126 | 1 |
| 3R | | 1126 | 1 |
| 4F | | 120 | 2 |
| 4B | | 200 | 3 |
| 15 | | 920 | 2 |
| STŘED | | | |
| W3 | | 1560 | 23 |
| W4 | | 1560 | 2 |
| W7 | | 1560 | 4 |
| 5 | | 1515 | 4 |
| 7F | | 1452 | 2 |
| 7B | | 1452 | 2 |
| 8L | | 1134 | 1 |
| 8R | 1134 | 1 | |
| 6L | | 1134 | 1 |
| 6R | | 1134 | 1 |
| 10 | | 100 | 3 |
| 12 | | 120 | 1 |
| 23 | | 980 | 1 |
| TOP1 | | | |
| 9F | | 1588 | 1 |
| 9B | | 1588 | 1 |
| 10F | | 350 | 2 |
| 11L | | 350 | 2 |
| 11R | | 350 | 2 |

| Č. | DÍL | MM | P |
|--------------|-----|----------|-----|
| 19 | | 944 | 2 |
| 19L | | 1065 | 2 |
| 19R | | 1065 | 2 |
| 20 | | 1279 | 4 |
| 21L | | 1156*350 | 2 |
| 21R | | 1156*350 | 2 |
| TOP2 | | | |
| W12 | | 1279 | 6 |
| W15 | | 1279 | 8 |
| 18 | | 1082 | 2 |
| 18Z | | 974 | 1 |
| DVEŘE | | | |
| 17L | | 1560 | 1 |
| 17R | | 1560 | 1 |
| M1 | | 1560x475 | 1 |
| M2 | | 1560x475 | 1 |
| 22 | | 475 | 6 |
| DÍLY | | | |
| A | | | 1 |
| B | | | 1 |
| C | | | 2 |
| D | | | 1 |
| E | | | 1 |
| F | | | 2 |
| F1 | | | 4 |
| F2 | | | 2 |
| F3 | | | 4 |
| F4 | | | 4 |
| F5 | | | 2 |
| F7 | | | 395 |
| F8 | | | 84 |
| F10 | | | 2 |

| | | |
|----|--|---|
| 1L | | 1 |
| 1R | | 1 |
| 4F | | 2 |
| S4 | | 4 |

01

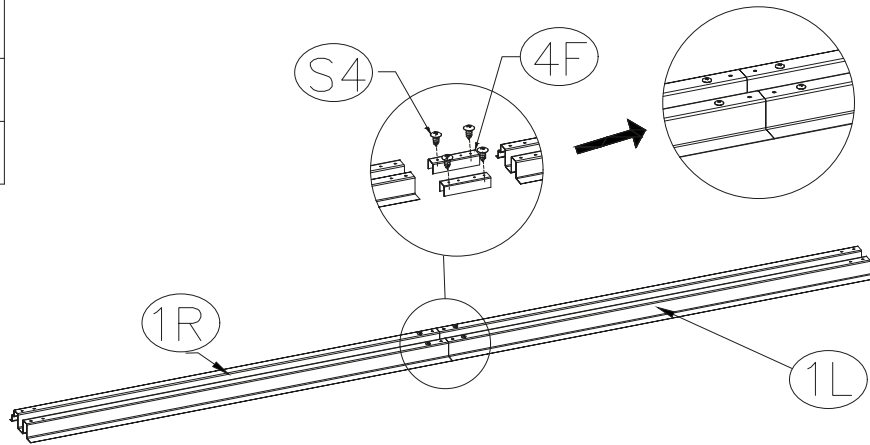

| | | |
|----|--|---|
| 15 | | 2 |
| S4 | | 8 |



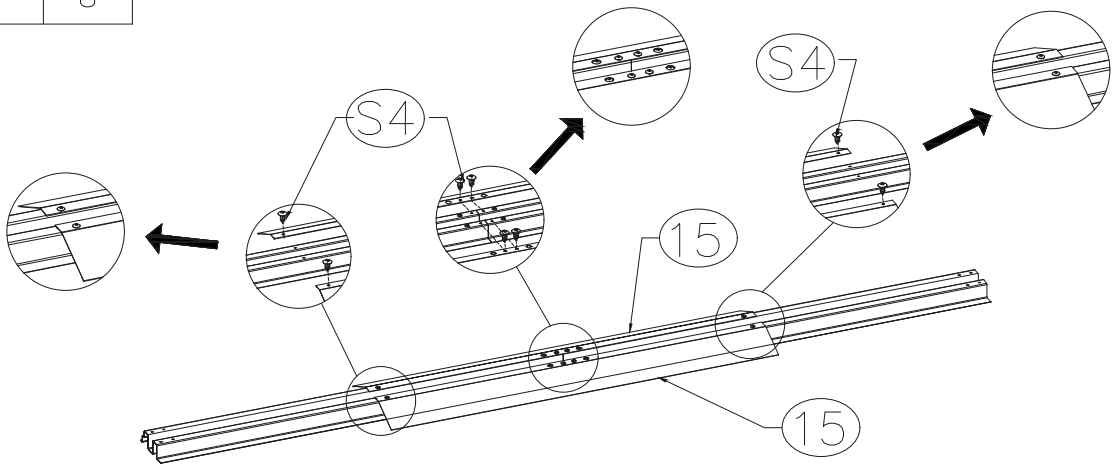

02



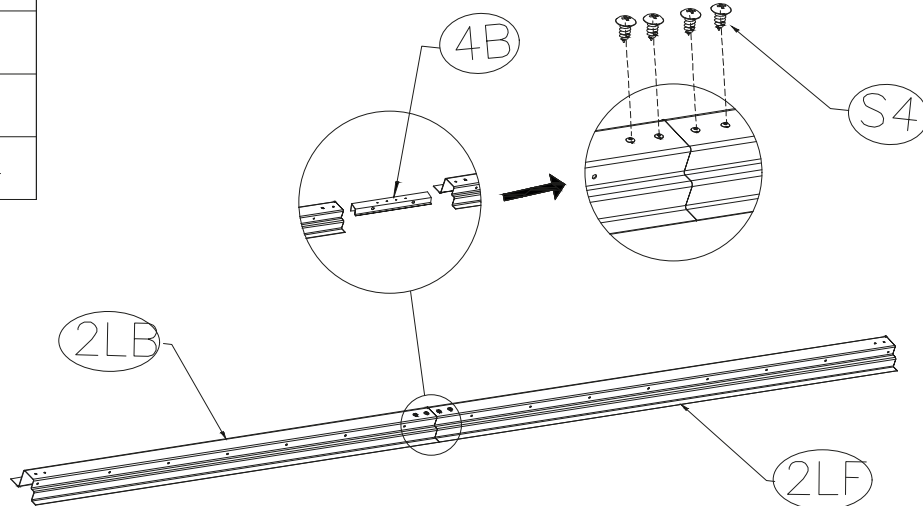



| | | |
|-----|--|---|
| 2LF | | 1 |
| 2LB | | 1 |
| 4B | | 1 |
| S4 | | 4 |

03

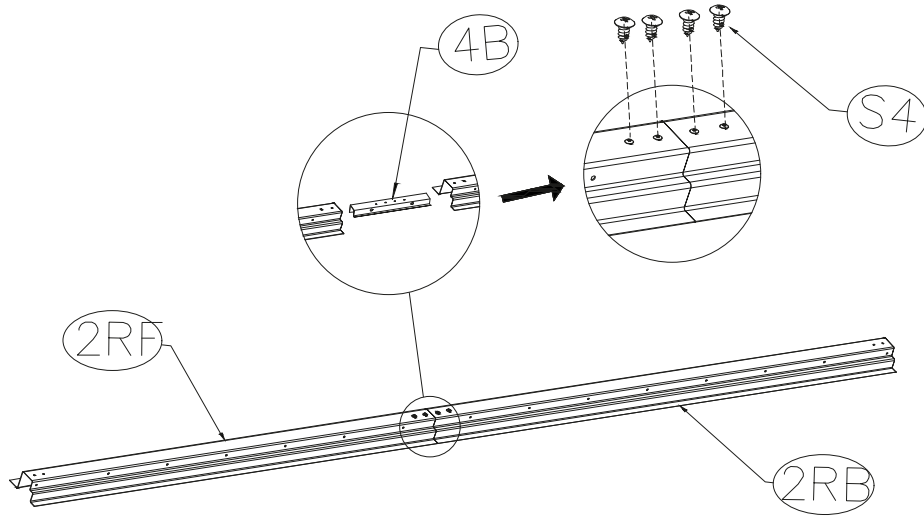





| | | |
|-----|---|---|
| 2RF |  | 1 |
| 2RB |  | 1 |
| 4B |  | 1 |
| S4 |  | 4 |

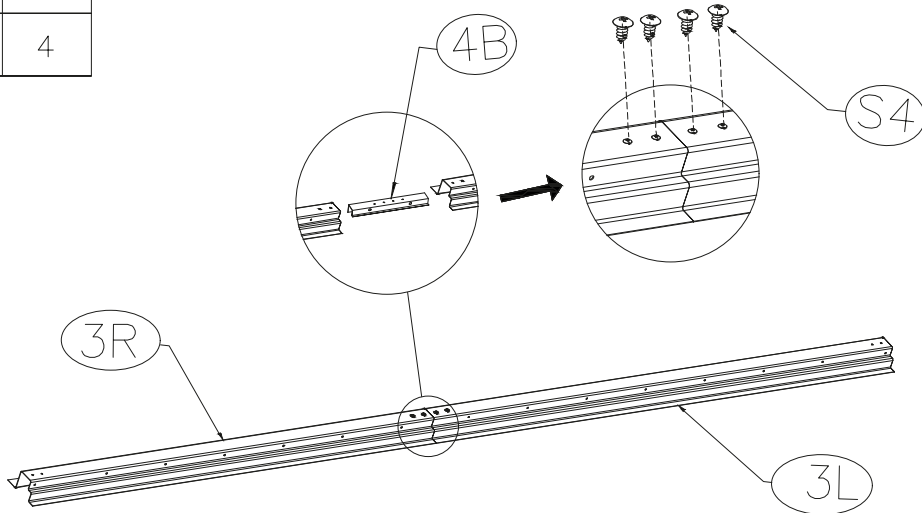

| | | |
|----|---|---|
| 3L |  | 1 |
| 3R |  | 1 |
| 4B |  | 1 |
| S4 |  | 4 |





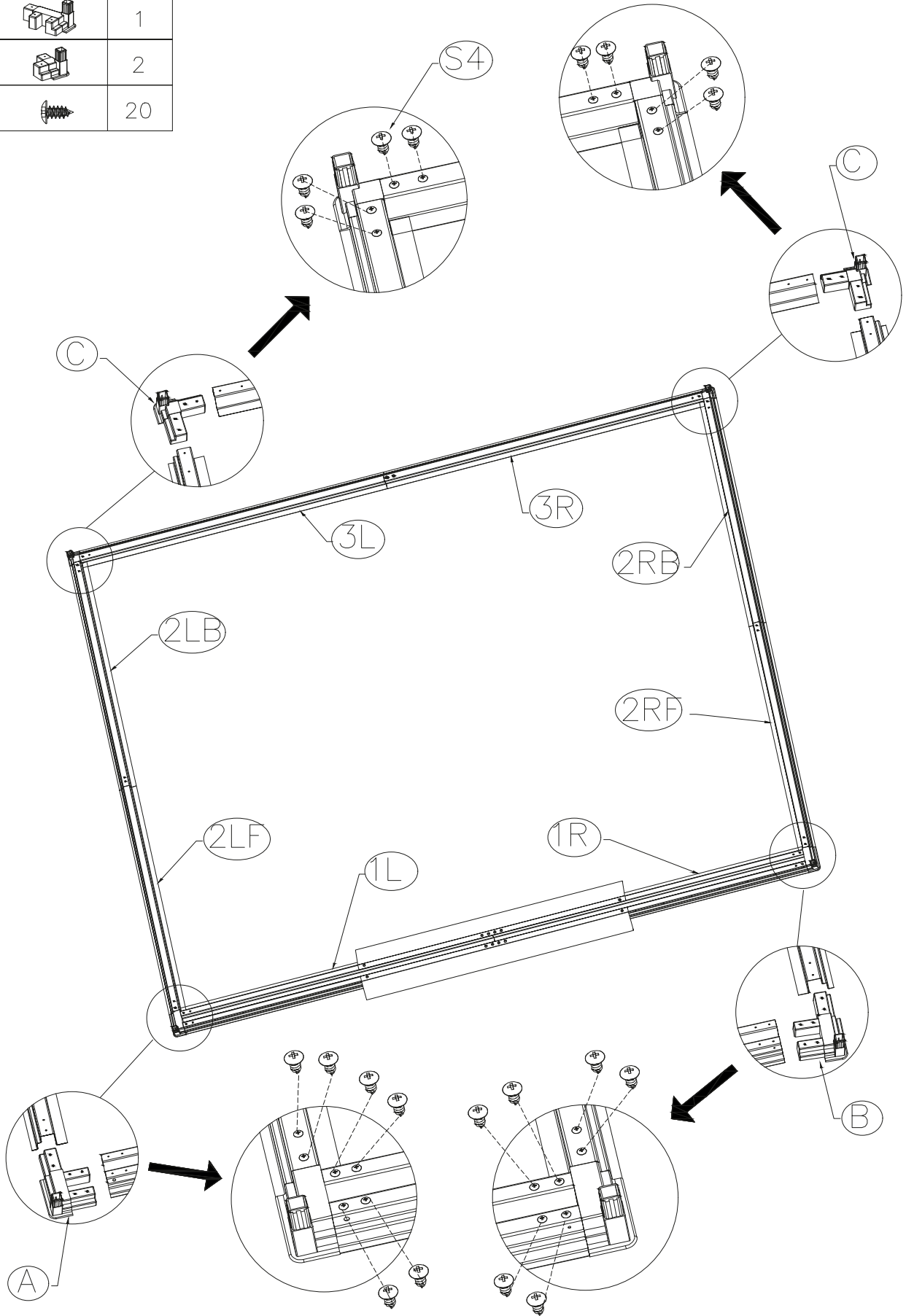



| | | |
|----|---|----|
| A |  | 1 |
| B |  | 1 |
| C |  | 2 |
| S4 |  | 20 |

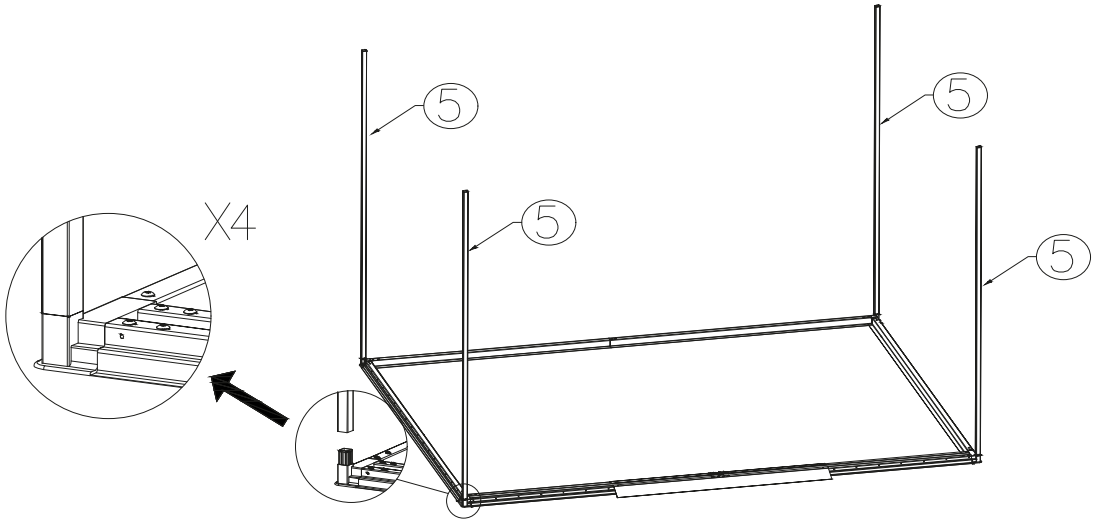

| | | |
|---|---|---|
| 5 |  | 4 |
|---|---|---|





07

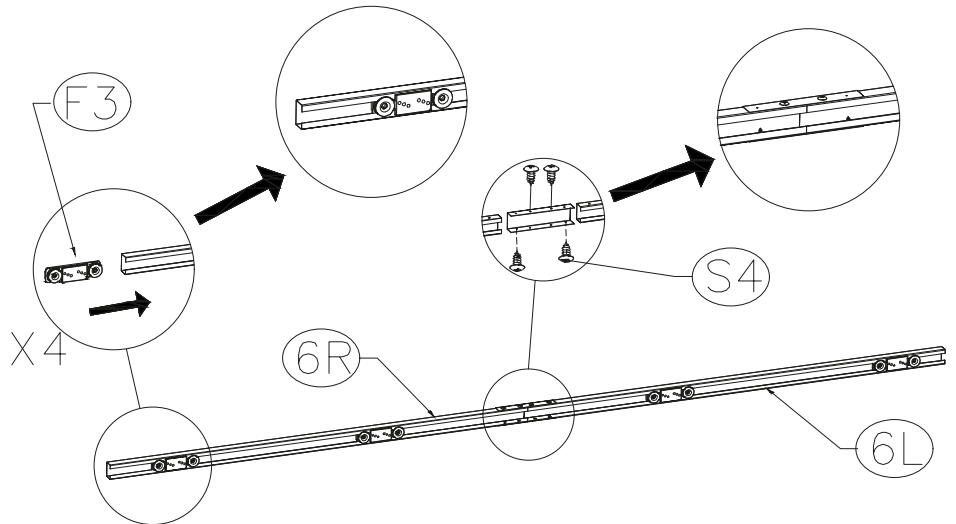

| | | |
|----|---|---|
| 6L |  | 1 |
| 6R |  | 1 |
| 12 |  | 1 |
| F3 |  | 4 |
| S4 |  | 4 |

08





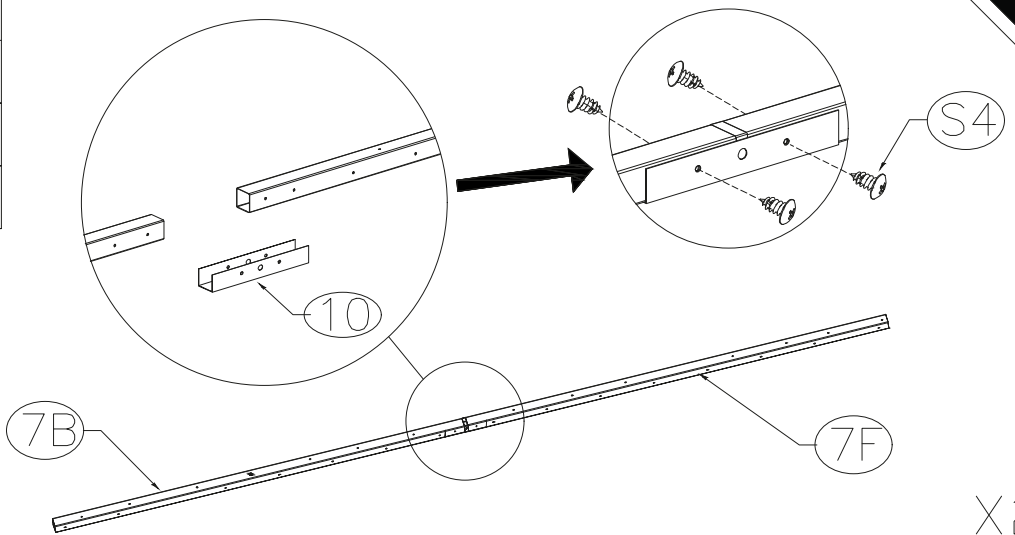
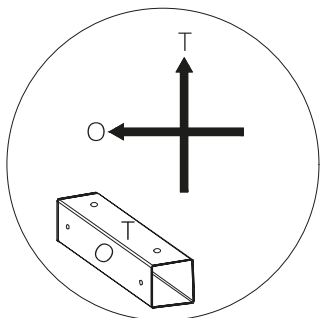

| | | |
|----|---|---|
| 7F |  | 2 |
| 7B |  | 2 |
| 10 |  | 2 |
| S4 |  | 8 |



09



X2

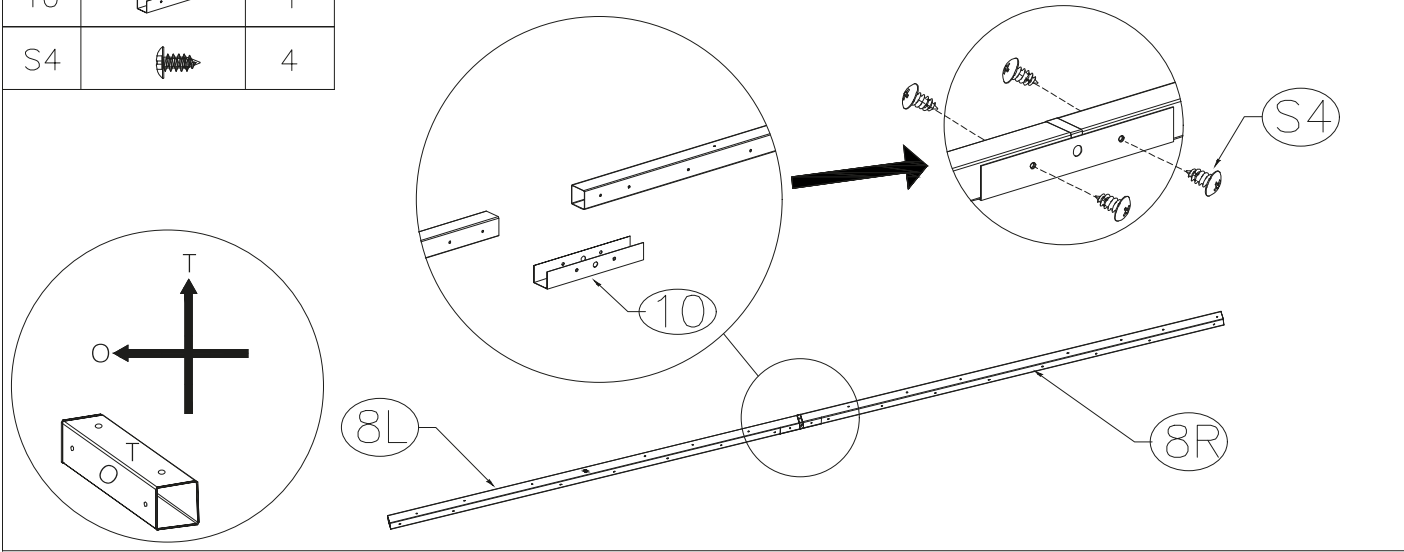

| | | |
|----|---|---|
| 8L |  | 1 |
| 8R |  | 1 |
| 10 |  | 1 |
| S4 |  | 4 |



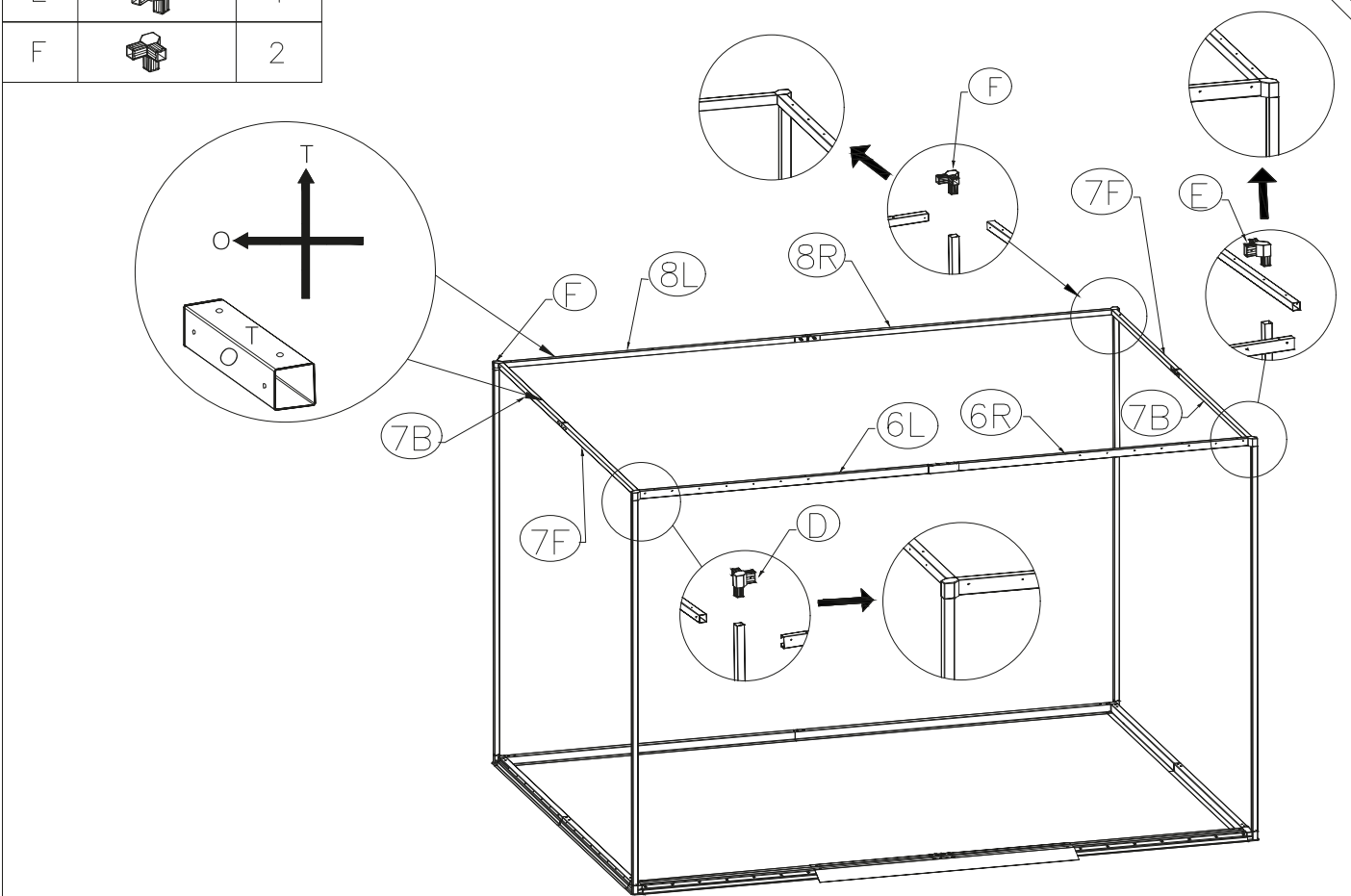



| | | |
|---|---|---|
| D |  | 1 |
| E |  | 1 |
| F |  | 2 |



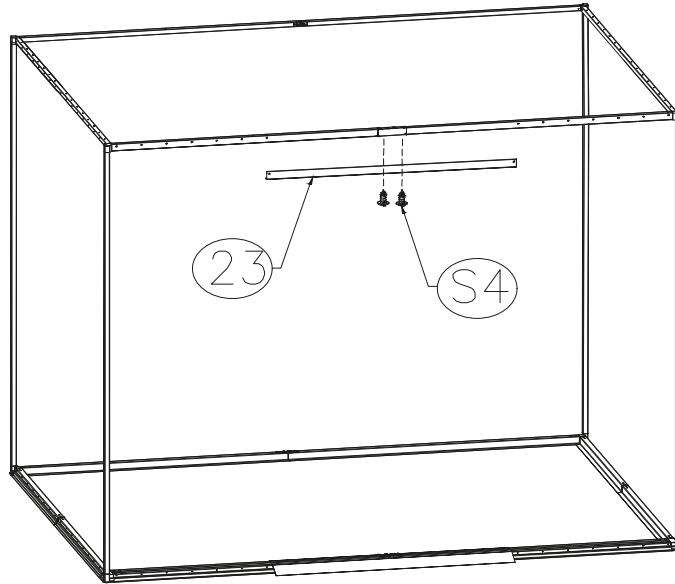



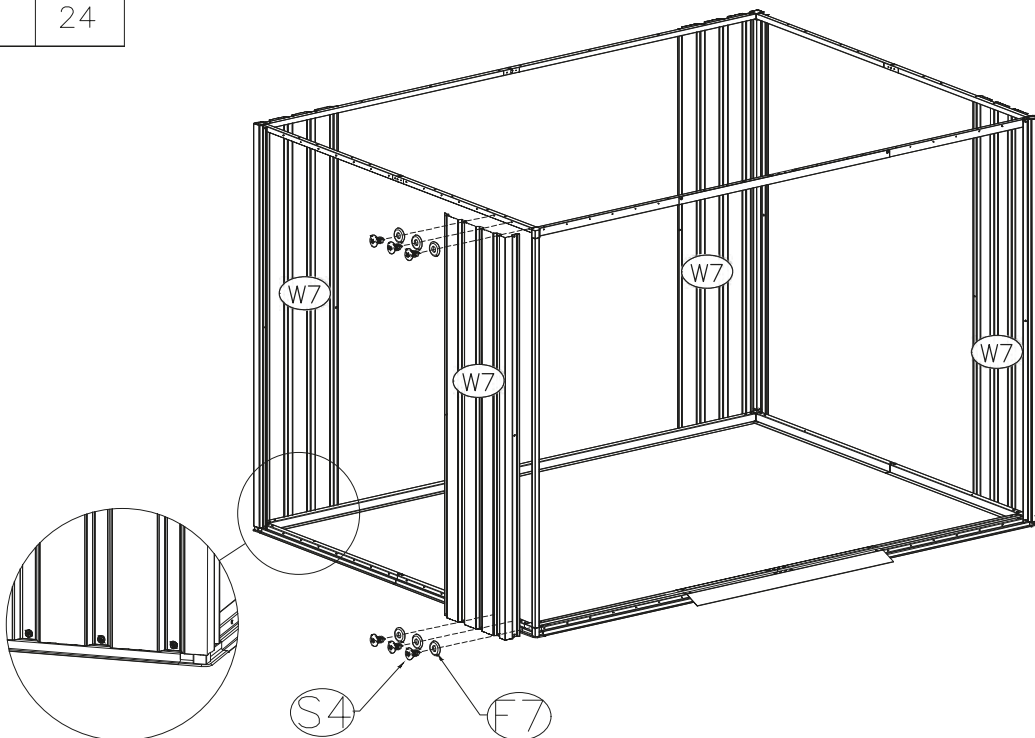

TIP: Při montáži věnujte pozornost směru otvorů!

| | | |
|----|---|---|
| 23 |  | 1 |
| S4 |  | 2 |







| | | |
|----|---|----|
| W7 |  | 4 |
| F7 |  | 24 |
| S4 |  | 24 |

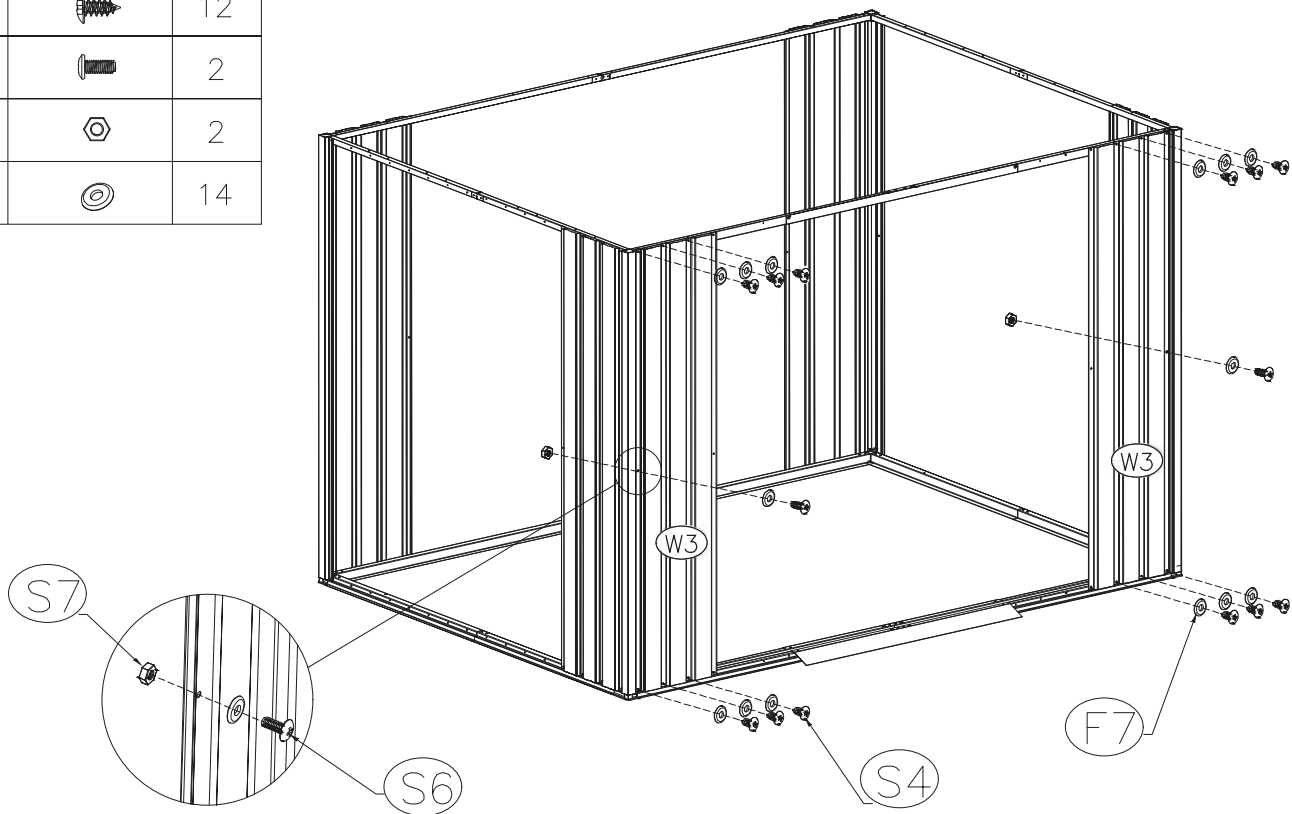





| | | |
|----|---|----|
| W3 |  | 2 |
| S4 |  | 12 |
| S6 |  | 2 |
| S7 |  | 2 |
| F7 |  | 14 |

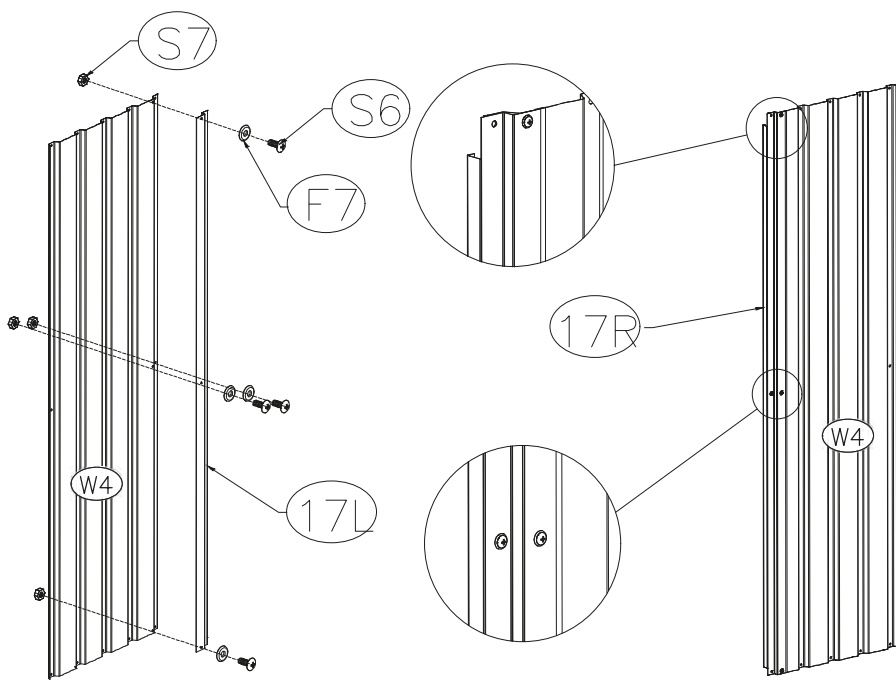





| | | |
|-----|---|---|
| 17L |  | 1 |
| 17R |  | 1 |
| S6 |  | 8 |
| S7 |  | 8 |
| F7 |  | 8 |

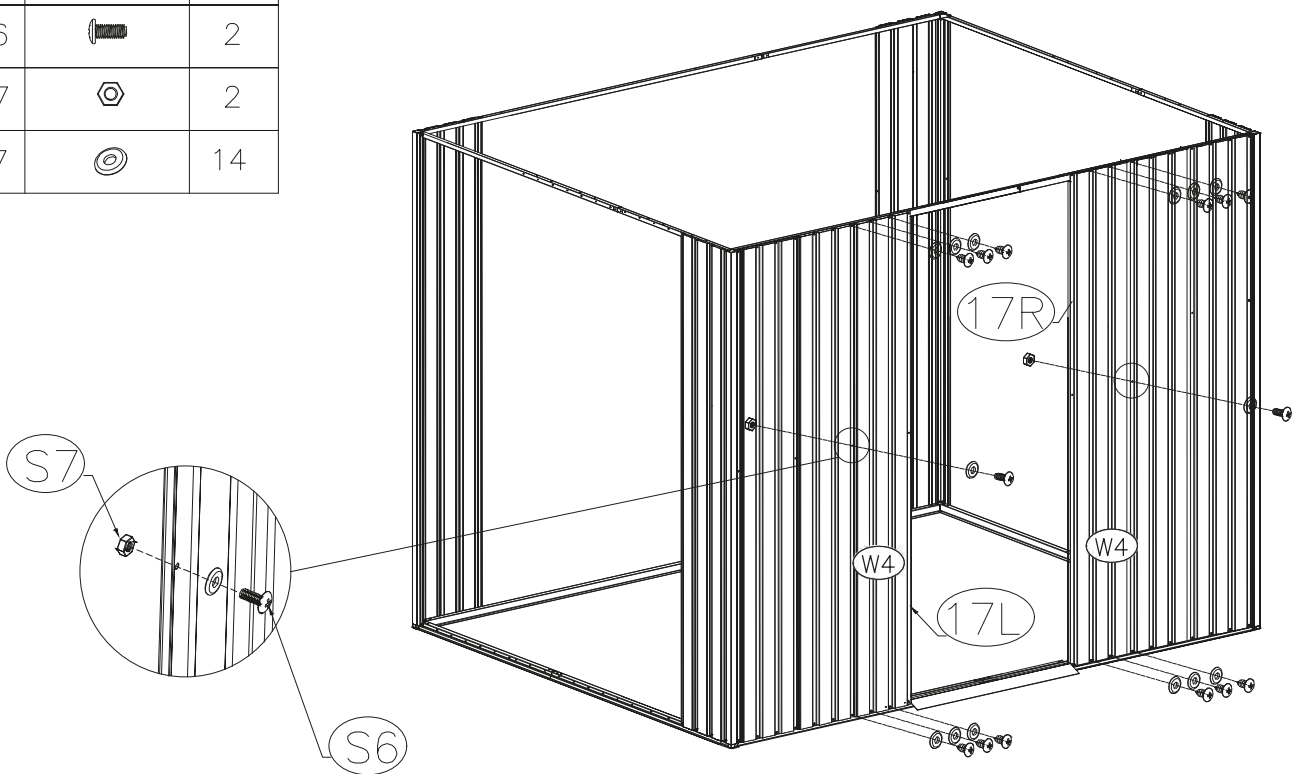





| | | |
|----|---|----|
| W4 |  | 2 |
| S4 |  | 12 |
| S6 |  | 2 |
| S7 |  | 2 |
| F7 |  | 14 |

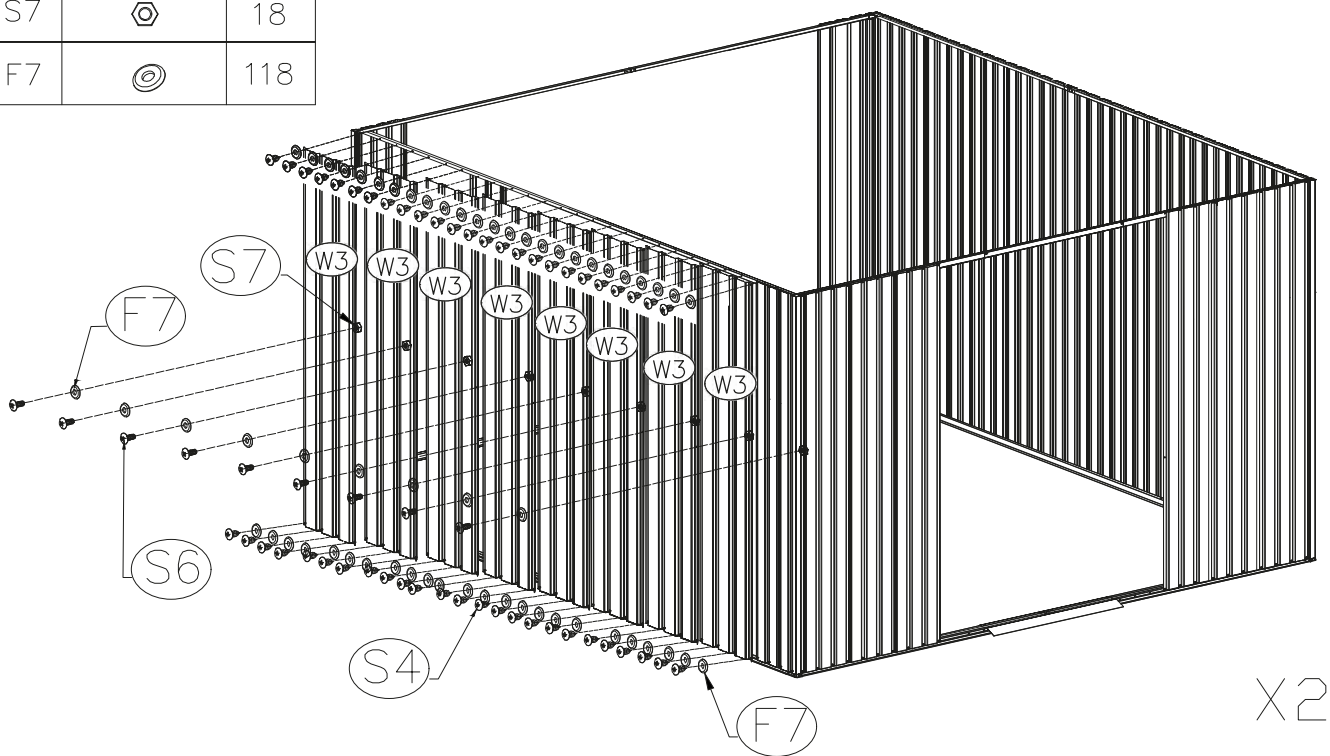







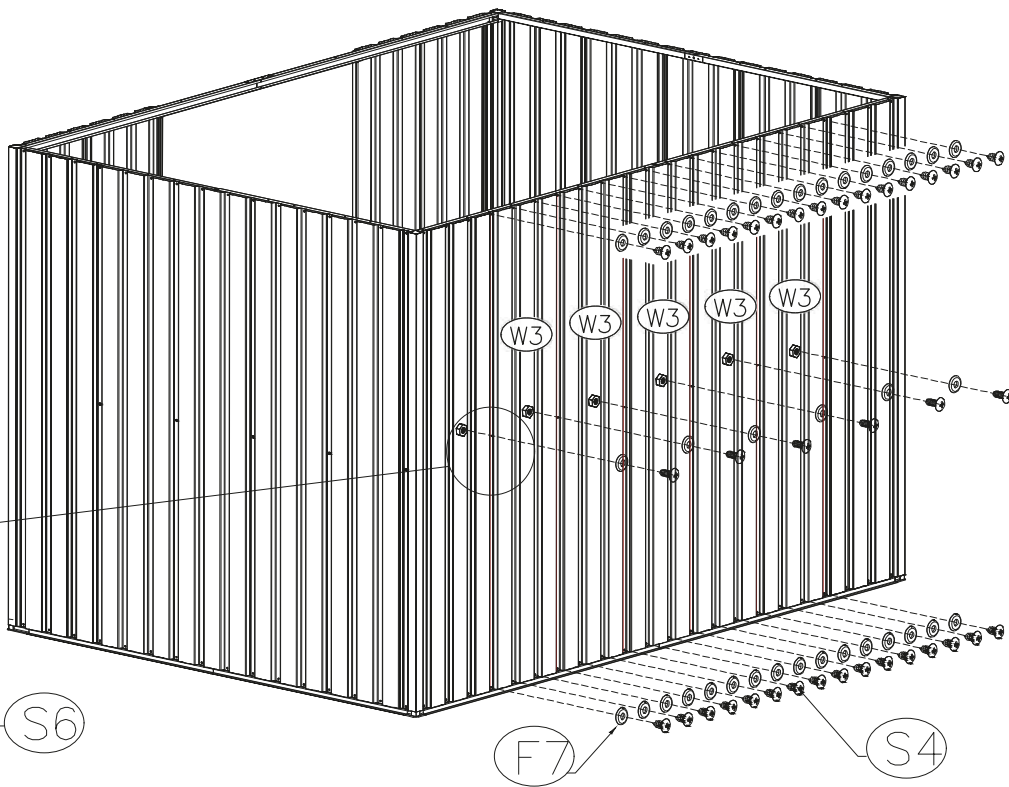

| | | |
|----|---|-----|
| W3 |  | 16 |
| S4 |  | 100 |
| S6 |  | 18 |
| S7 |  | 18 |
| F7 |  | 118 |



X2

| | | |
|----|---|----|
| W3 |  | 5 |
| S4 |  | 32 |
| S6 |  | 6 |
| S7 |  | 6 |
| F7 |  | 38 |



| | | |
|-----|---|---|
| 10F |  | 2 |
| 11L |  | 2 |
| 11R |  | 2 |
| 21L |  | 2 |
| 21R |  | 2 |
| S6 |  | 6 |
| S7 |  | 6 |

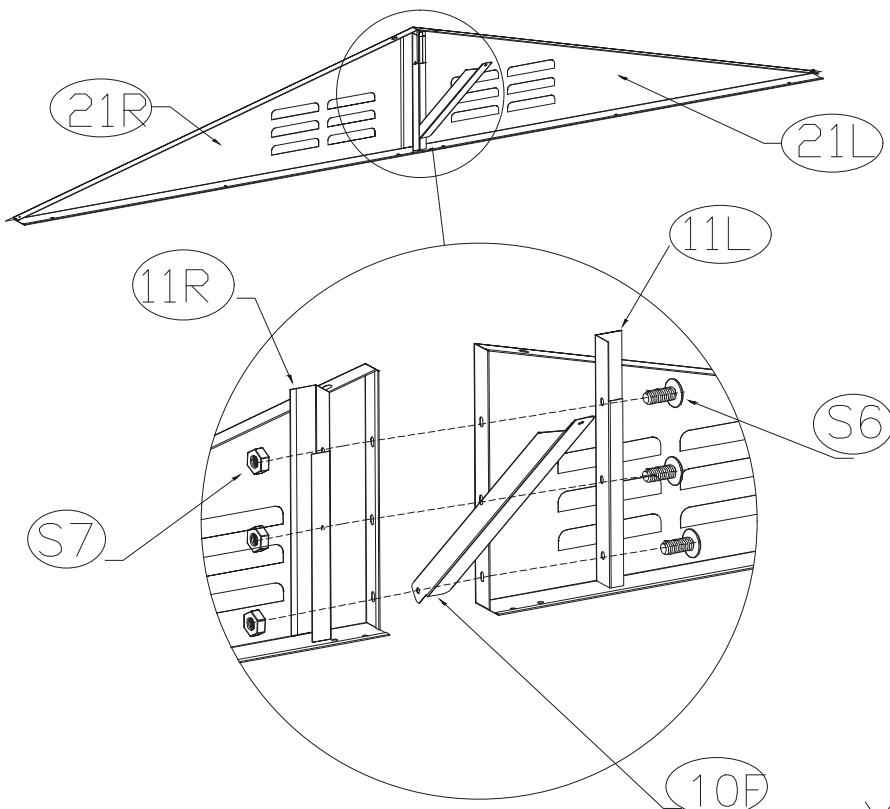

X2

S4



20

20

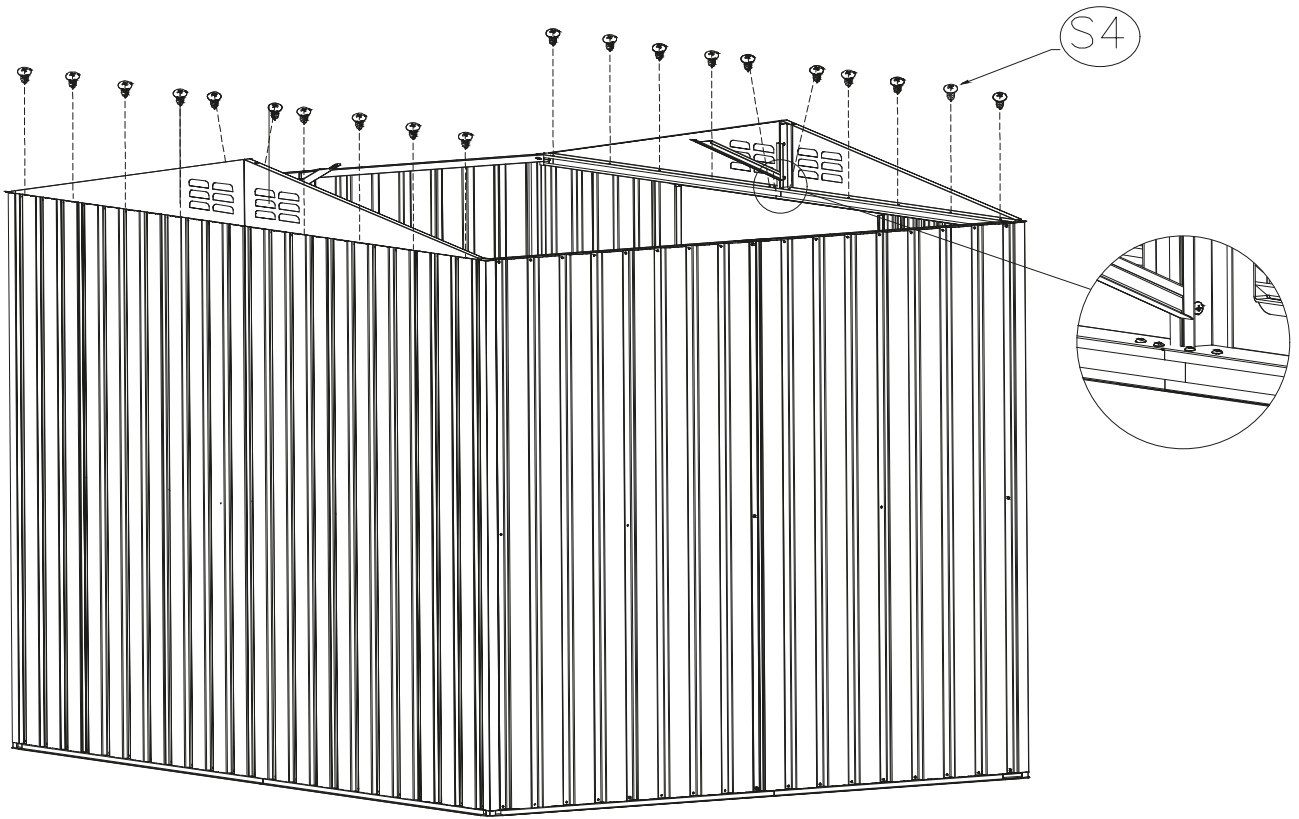

| | | |
|----|--|----|
| 9F | | 1 |
| 9B | | 1 |
| S6 | | 12 |
| S7 | | 12 |

21

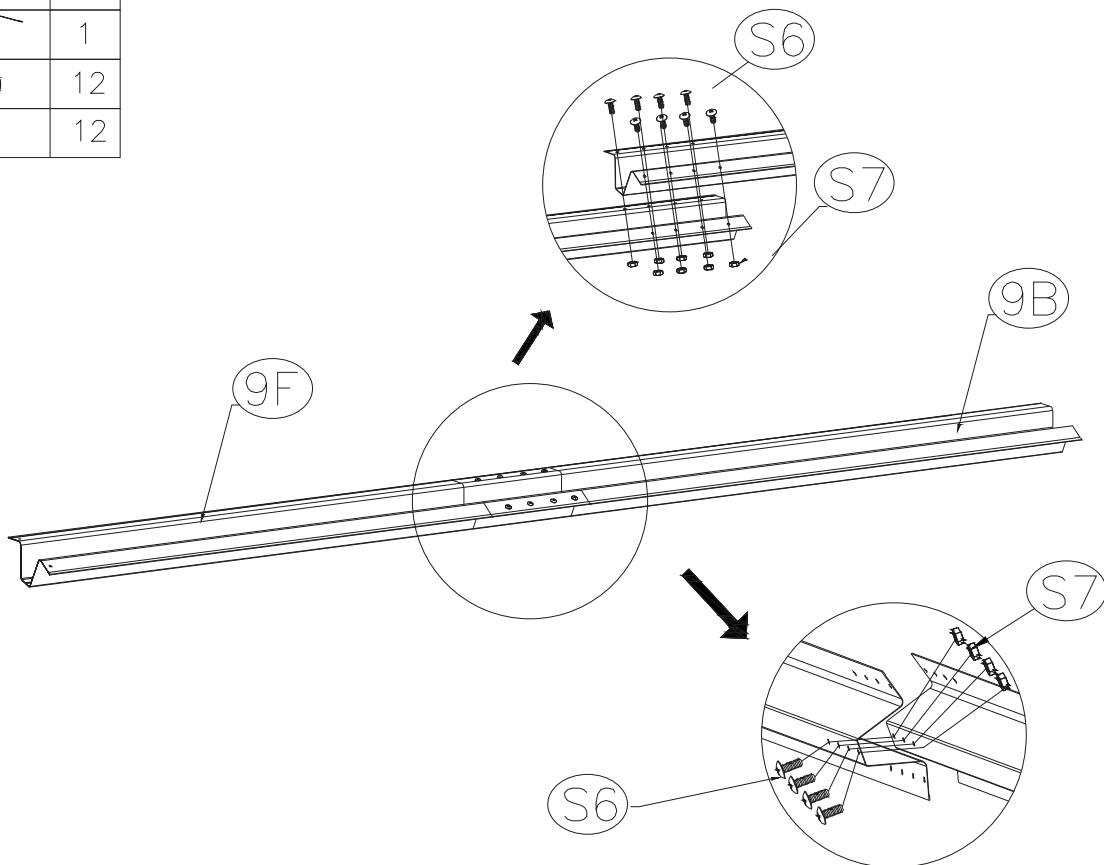

S4



2

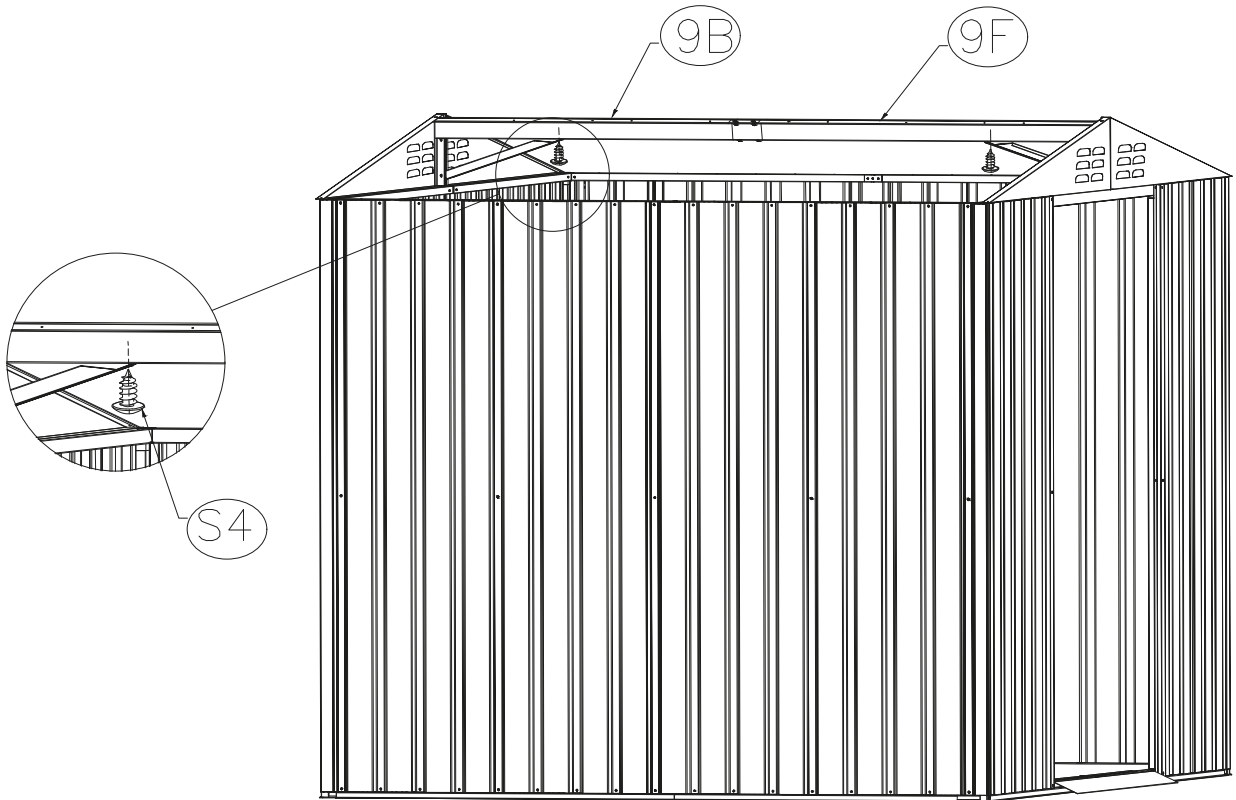

22





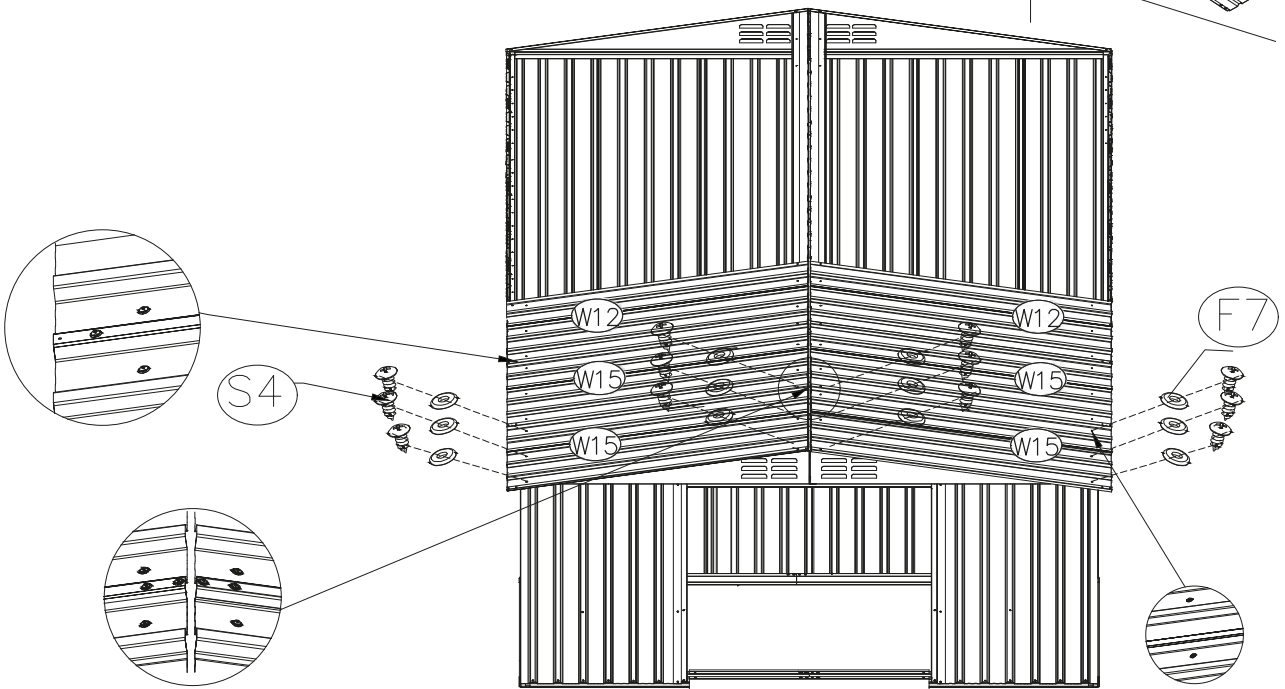
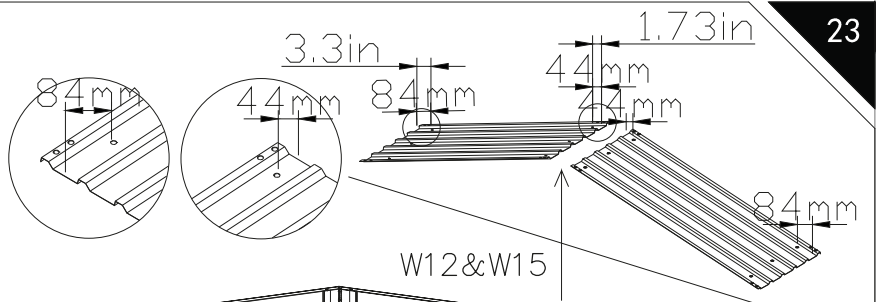

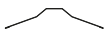
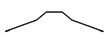
| | | |
|-----|--|----|
| W15 | | 4 |
| W12 | | 2 |
| S4 | | 42 |
| F7 | | 42 |

23

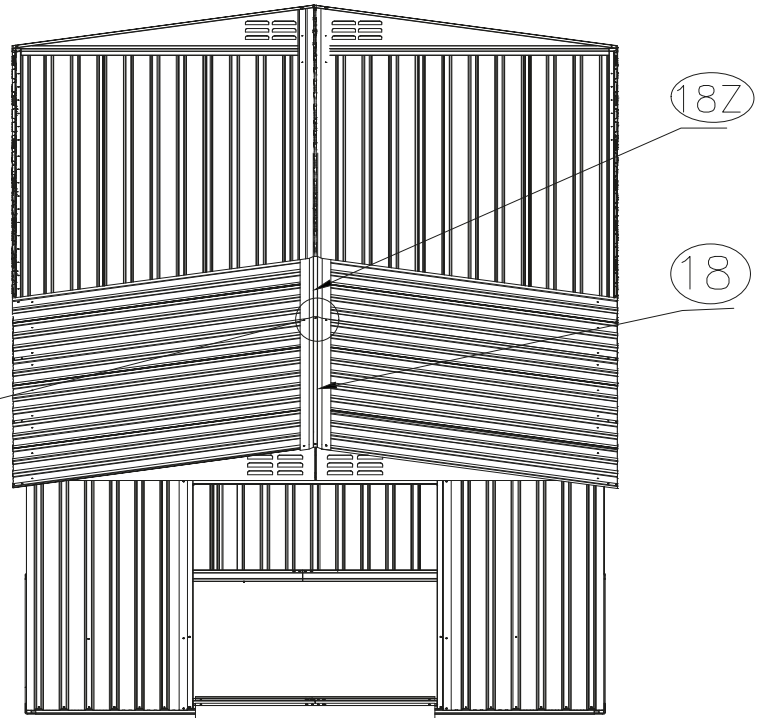
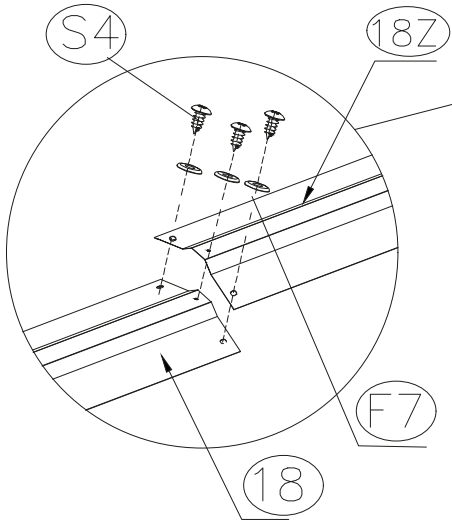



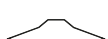

| | | |
|-----|---|---|
| 18 |  | 1 |
| 18Z |  | 1 |
| S4 |  | 3 |
| F7 |  | 3 |

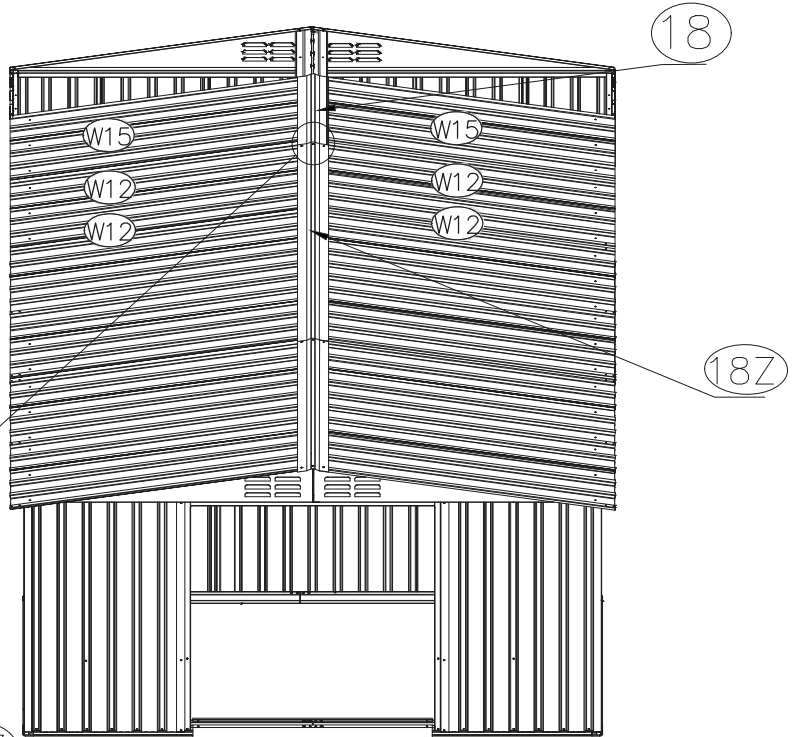
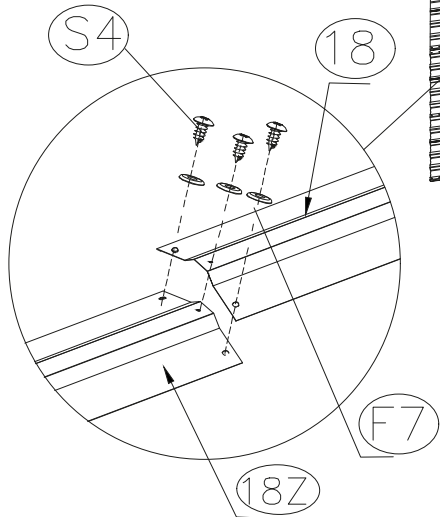







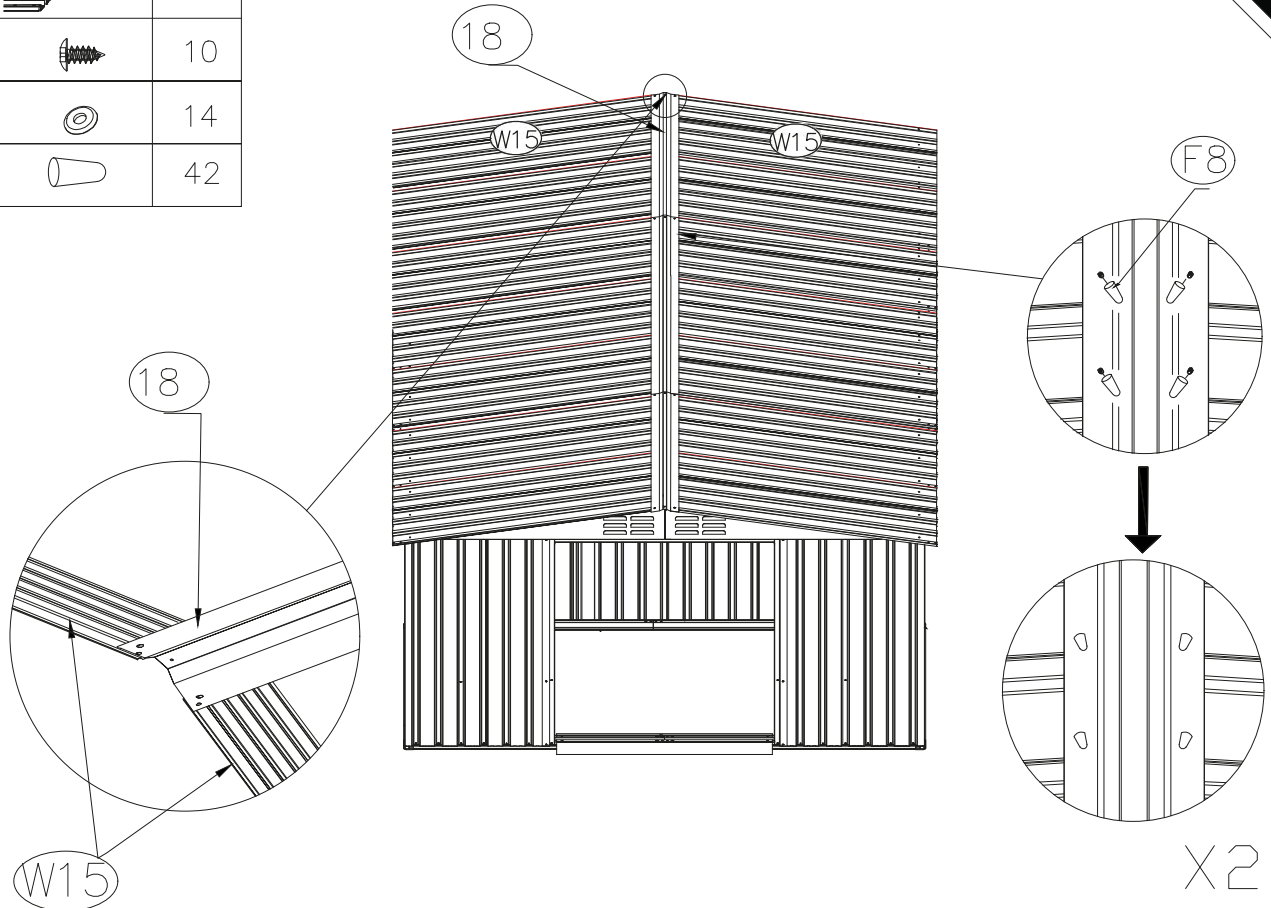

| | | |
|-----|---|----|
| W12 |  | 4 |
| W15 |  | 2 |
| 18 |  | 1 |
| S4 |  | 46 |
| F7 |  | 46 |







X2

| | | |
|-----|---|----|
| W15 |  | 2 |
| S4 |  | 10 |
| F7 |  | 14 |
| F8 |  | 42 |

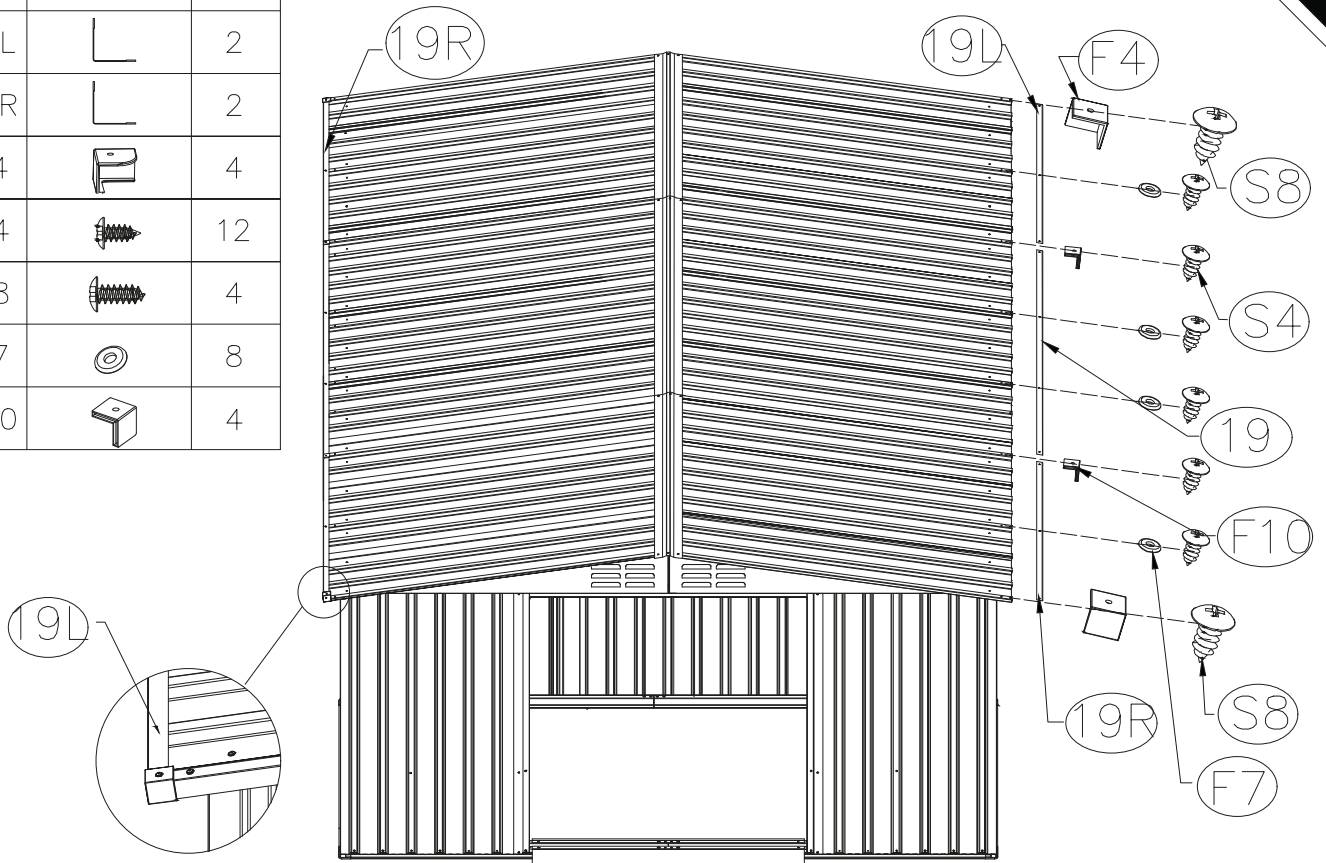





| | | |
|-----|---|----|
| 19 |  | 2 |
| 19L |  | 2 |
| 19R |  | 2 |
| F4 |  | 4 |
| S4 |  | 12 |
| S8 |  | 4 |
| F7 |  | 8 |
| F10 |  | 4 |

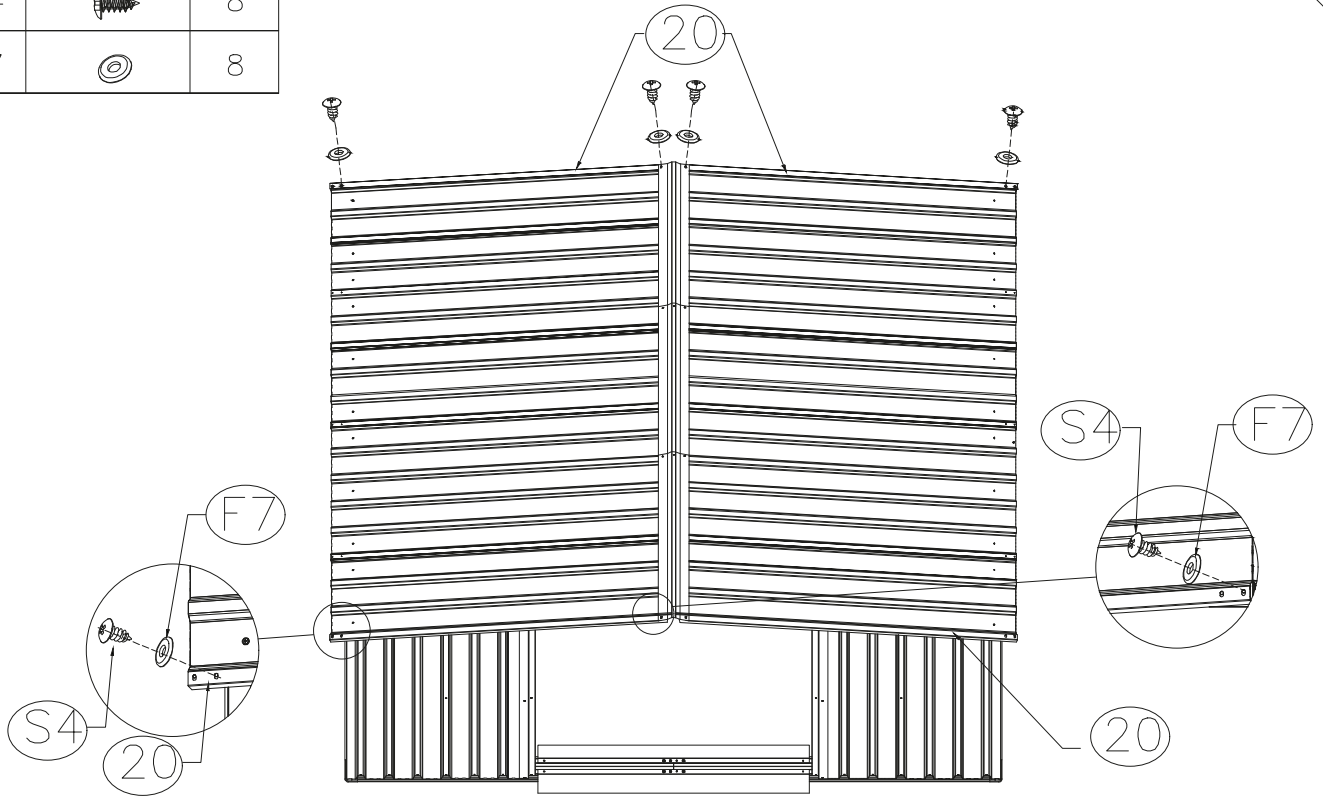





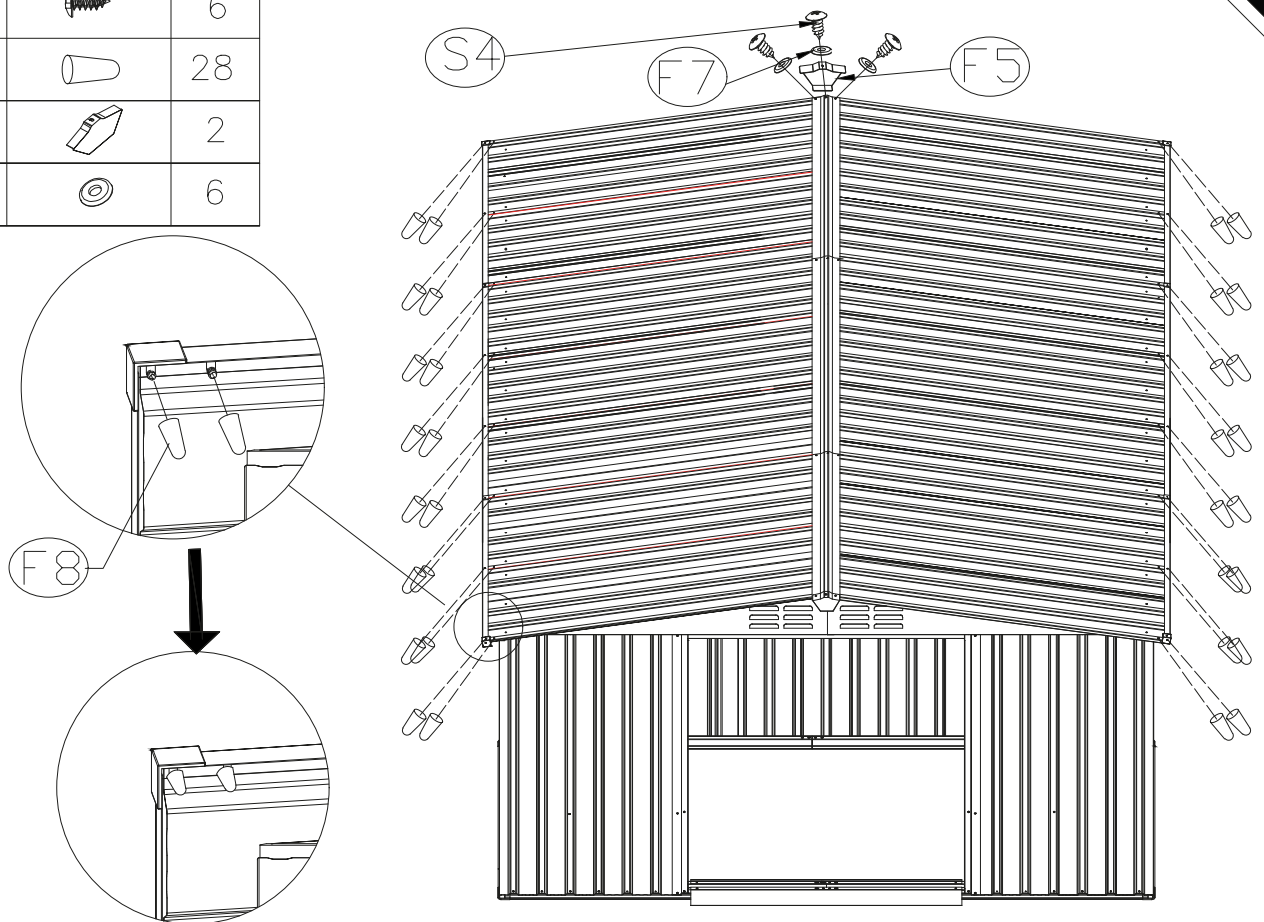

| | | |
|----|---|---|
| 20 |  | 4 |
| S4 |  | 8 |
| F7 |  | 8 |





| | | |
|----|---|----|
| S4 |  | 6 |
| F8 |  | 28 |
| F5 |  | 2 |
| F7 |  | 6 |



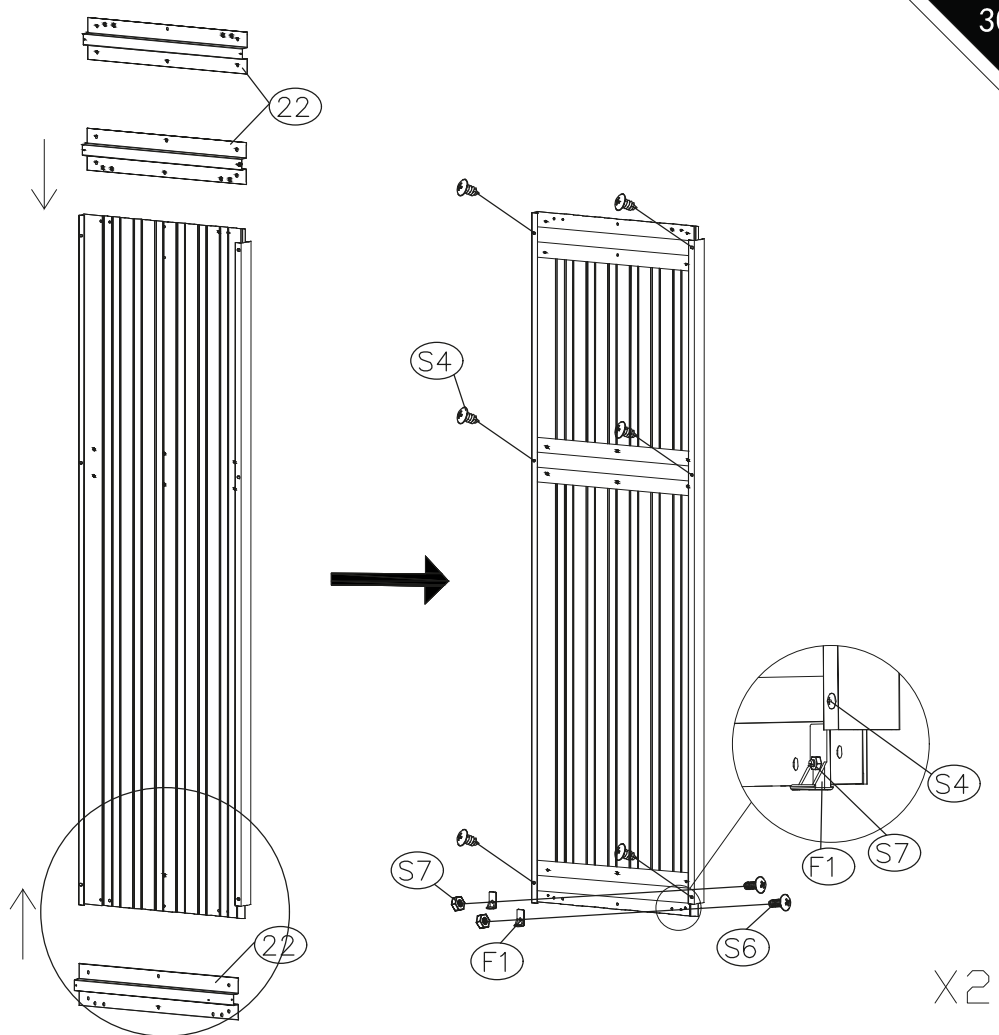
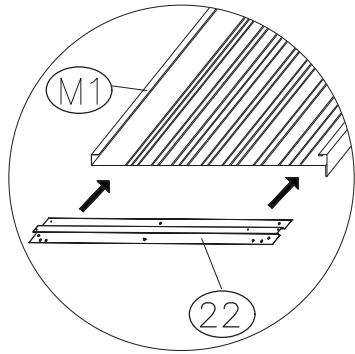

| | | |
|----|---|----|
| M1 |  | 1 |
| M2 |  | 1 |
| 22 |  | 6 |
| F1 |  | 4 |
| S4 |  | 12 |
| S6 |  | 8 |
| S7 |  | 8 |

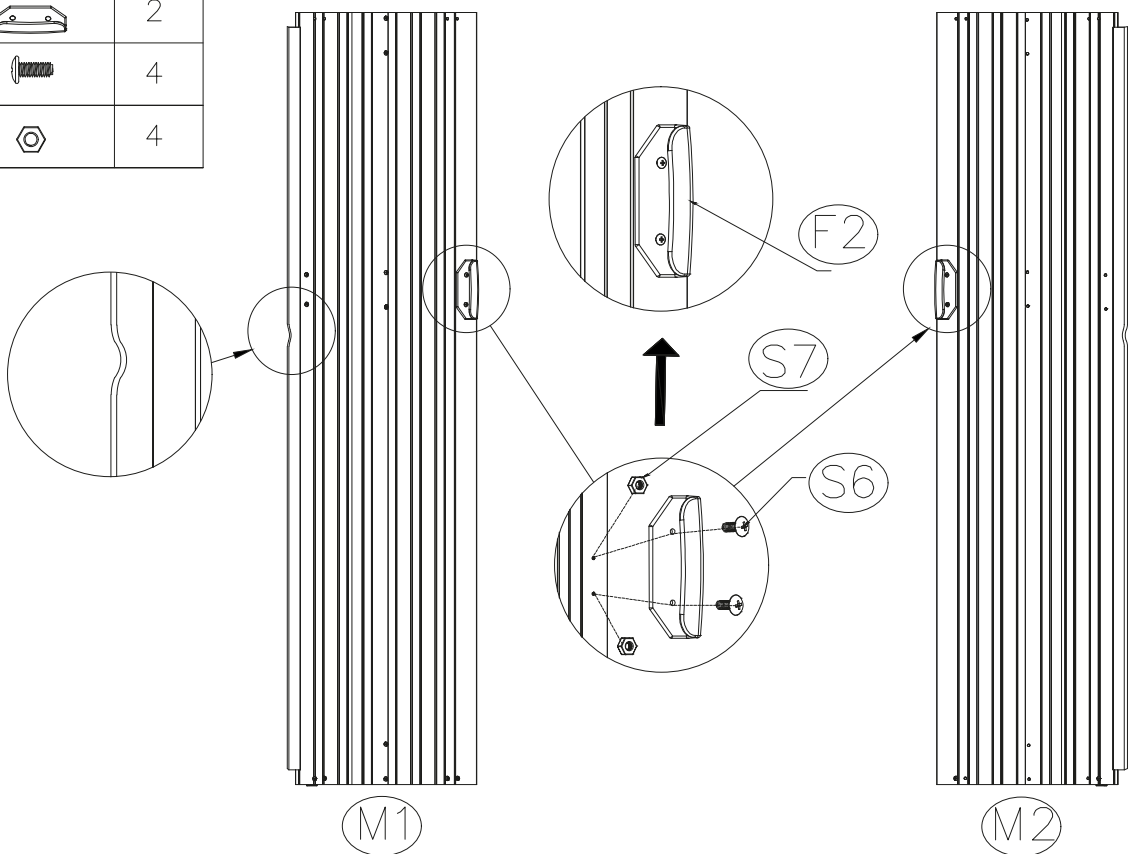

| | | |
|----|---|---|
| F2 |  | 2 |
| S6 |  | 4 |
| S7 |  | 4 |



| | | |
|----|---|----|
| S6 |  | 20 |
| S7 |  | 20 |
| F7 |  | 12 |

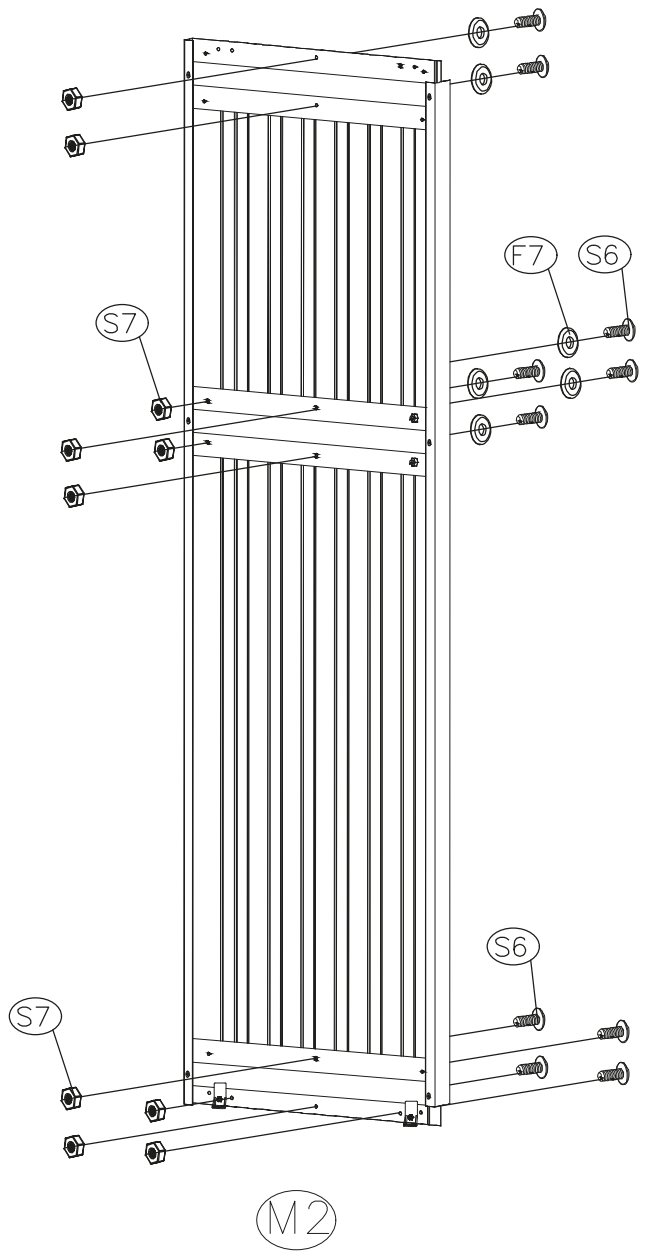
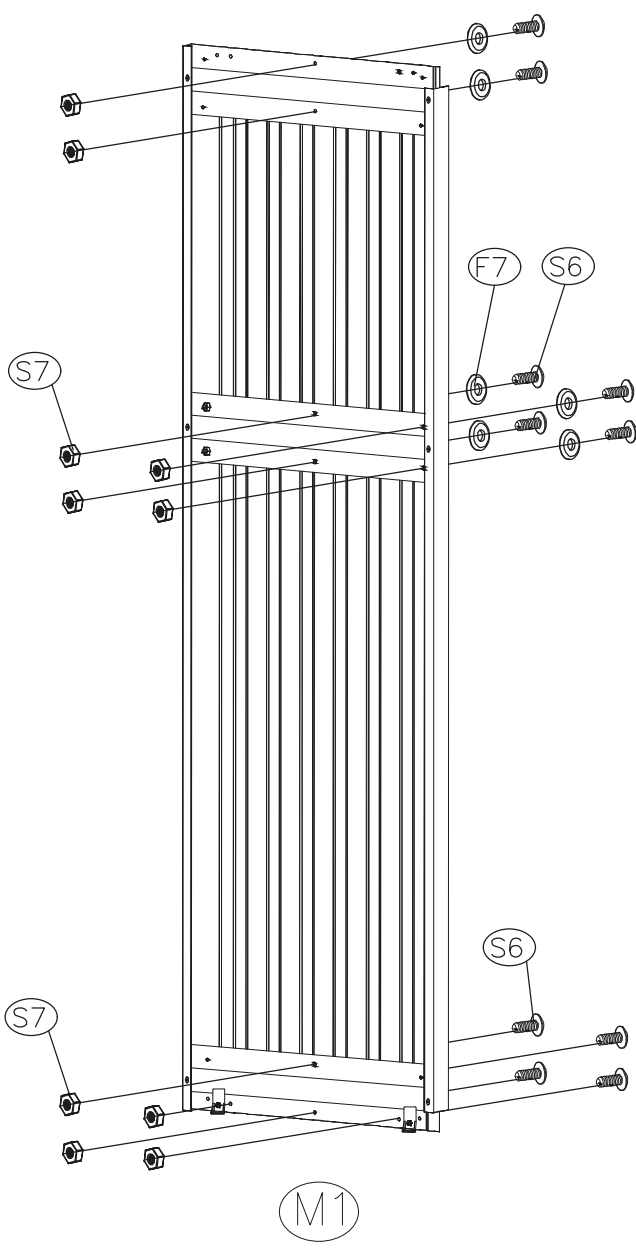

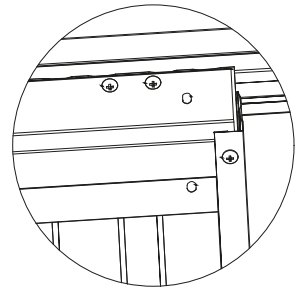
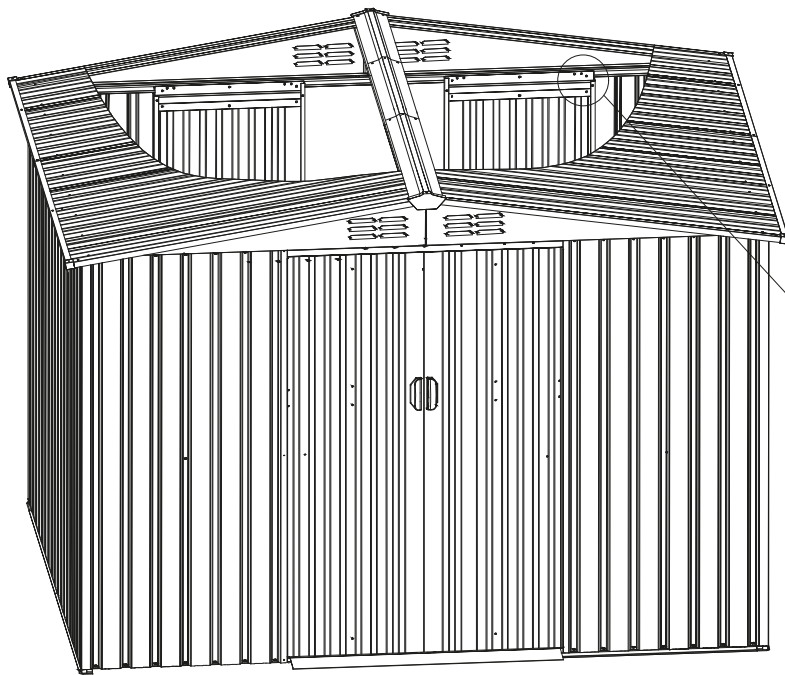

X4

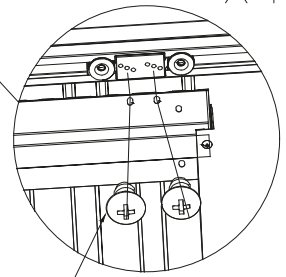

S8

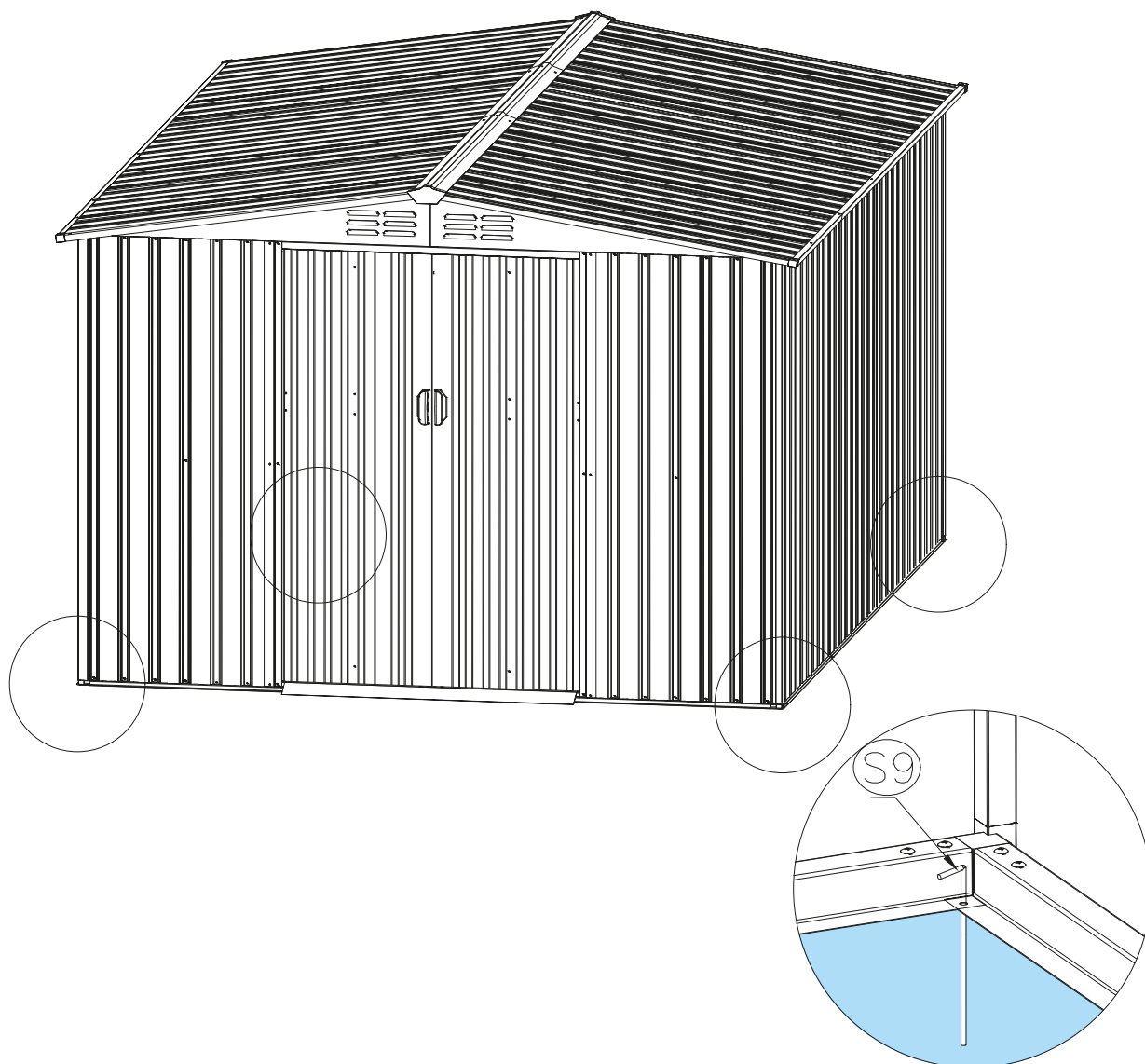

Pokud je domek instalován na trávě, může se díl [S9] použít ke zvýšení stability domku.